



# Bridgelux® Vero® SE 13 Array Series

Product Data Sheet DS121



# Introduction

Vero SE



Vero® SE represents a state of the art COB solution with revolutionary advancements in LED integration technology. Vero SE's innovative light source system integrates Bridgelux's seventh generation COB technology with poke-in connectivity that enables solder free installation. Vero SE LED light sources streamline assembly processes, lower manufacturing cost, simplify luminaire design, improve light quality and increase design flexibility.

Vero SE poke-in connectivity simplifies manufacturing and assembly processes by eliminating the need to solder. Secondary connector and holder components are not required, allowing for rapid integration of arrays into fixtures and an efficient field replaceable solution.

Vero SE is available in four different light emitting surface (LES) configurations and has been engineered to reliably operate over a broad current range, enabling new degrees of flexibility in luminaire design optimization. Vero SE arrays deliver increased lumen density for improved beam control and precision lighting with 2 and 3 SDCM color control standards for clean and consistent uniform lighting.

Bridgelux Décor Series is our state of the art color line designed specifically for premium applications, producing unmatched LED light quality with brilliant color-rendering options. Light and color are powerful mediums that influence experience and well-being, and Décor Series LEDs offer pleasing lighting palettes that are inspiring. Bridgelux Décor Series color points are available on Vero® SE Series, Vero® Series, and H Series™.

**Décor Series Class A** is based on human response testing, providing color points with a combined GAI and CRI metric.

**Décor Series™ Ultra** products provide a high CRI of 97, which emphasizes the reds and color tones to which the human eye is most receptive - perfect for the most luxurious retail shops and world renowned museums. Décor Series Ultra is also a good replacement for halogen.

## Features

- Poke-in connectivity
- Efficacy of 151 lm/W typical
- Vero SE 13 lumen output performance ranges from 511 to 6,931 lumens
- Broad range of CCT options from 2700K to 6500K
- CRI options: minimum 70, 80, and 90
- Color control: 2 and 3 SDCM for 2700K-4000K CCT
- Reliable operation at up to 2X nominal drive current
- Radial die pattern and improved lumen density
- Top side part number markings
- No exposed solder pads or electrical connections
- V<sub>r</sub> bin code backside marking

## Benefits

- Poke-in connectivity enables solderless, connector free installation
- Broad application coverage for interior and exterior lighting
- Flexibility for application driven lighting design requirements
- High quality, true color reproduction
- Uniform consistent white light
- Flexibility in design optimization
- Enhanced ease of use and assembly
- Ability to configure multiple Vero SE arrays in series and parallel reduces customer driver cost
- Improved inventory management and quality control



# Contents

Product Feature Map	2
Product Nomenclature	2
Product Selection Guide	3
Performance at Commonly Used Drive Currents	8
Electrical Characteristics	15
Eye Safety	16
Absolute Maximum Ratings	17
Performance Curves	18
Typical Radiation Pattern	21
Typical Color Spectrum	22
Mechanical Dimensions	23
Color Binning Information	24
Packaging and Labeling	25
Design Resources	27
Precautions	27
Disclaimers	27
About Bridgelux	28

# Product Feature Map

Vero SE 13 is the second smallest form factor in the product family of the next generation solid state light sources. In addition to delivering the performance and light quality required for many lighting applications,

Vero SE incorporates several features to simplify the design integration and manufacturing process, accelerate time to market and reduce system costs. Please visit [www.bridgelux.com](http://www.bridgelux.com) for more information on the Vero SE family of products.

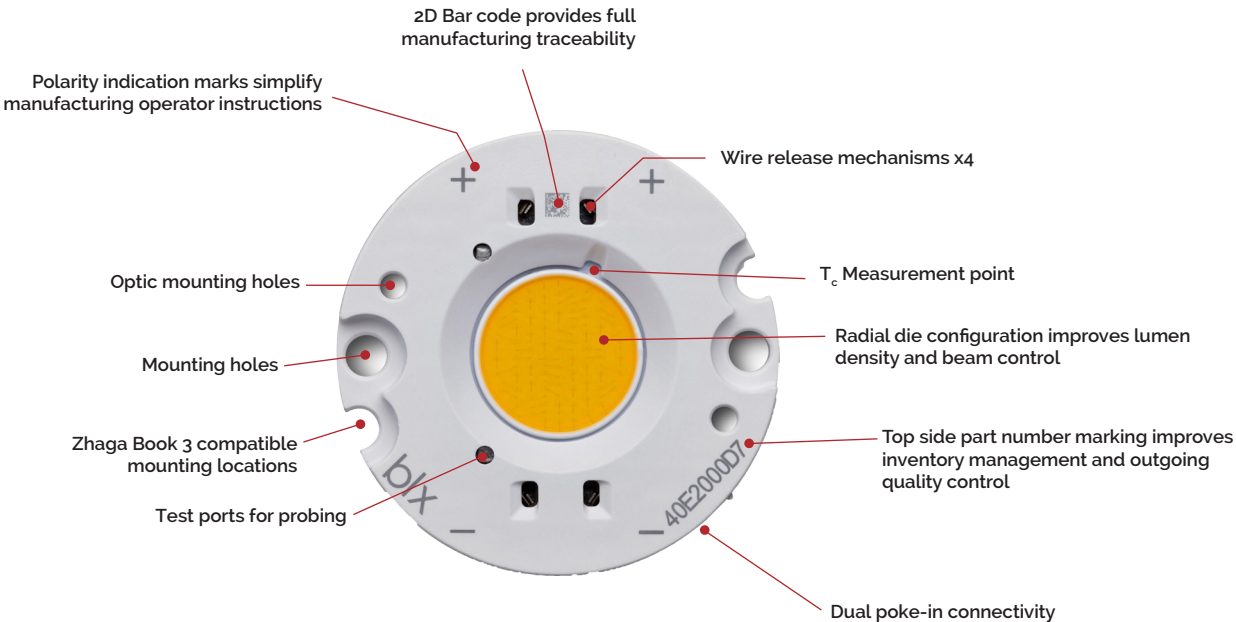

## Product Nomenclature

The part number designation for Bridgelux Vero SE LED arrays is explained as follows:

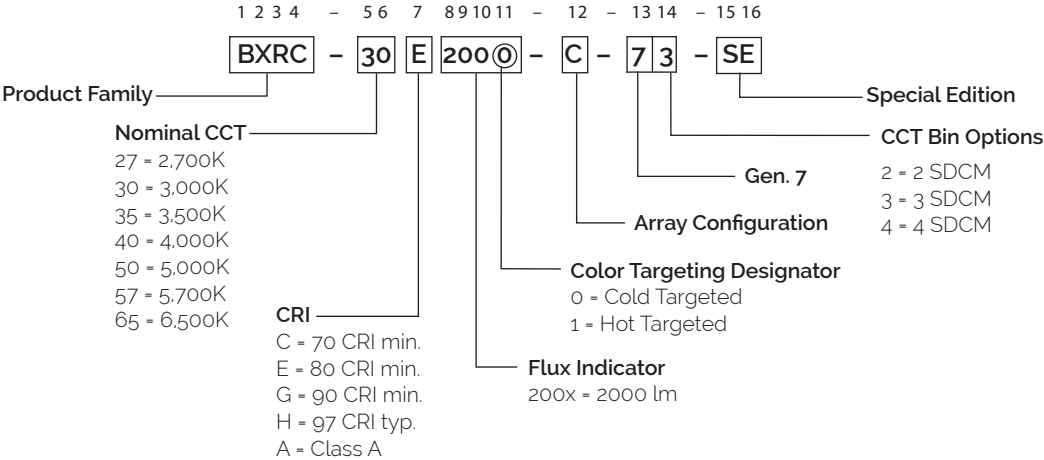

# Product Selection Guide

The following product configurations are available:

**Table 1:** Selection Guide, Pulsed Measurement Data ( $T_j = T_c = 25^\circ\text{C}$ )

Part Number	Nominal CCT <sup>1</sup> (K)	CRI <sup>2</sup>	Nominal Drive Current <sup>3</sup> (mA)	Typical Pulsed Flux <sup>4,5,6</sup> $T_c = 25^\circ\text{C}$ (lm)	Minimum Pulsed Flux <sup>6,7</sup> $T_c = 25^\circ\text{C}$ (lm)	Typical $V_f$ (V)	Typical Power (W)	Typical Efficacy (lm/W)
BXRC-27E2000-B-7X-SE	2700	80	450	2276	2048	35.0	15.8	145
BXRC-27E2000-C-7X-SE	2700	80	630	3186	2867	35.0	22.1	145
BXRC-27E2000-D-7X-SE	2700	80	500	2318	2086	31.8	15.9	146
BXRC-27G2000-B-7X-SE	2700	90	450	1897	1707	35.0	15.8	120
BXRC-27G2000-C-7X-SE	2700	90	630	2655	2389	35.0	22.1	120
BXRC-27G2000-D-7X-SE	2700	90	500	1932	1739	31.8	15.9	121
BXRC-27H2000-B-7X-SE	2700	97	450	1664	1498	35.0	15.8	106
BXRC-27H2000-C-7X-SE	2700	97	630	2330	2097	35.0	22.1	106
BXRC-27H2000-D-7X-SE	2700	97	500	1695	1526	31.8	15.9	107
BXRC-30E2000-B-7X-SE	3000	80	450	2372	2134	35.0	15.8	151
BXRC-30E2000-C-7X-SE	3000	80	630	3319	2987	35.0	22.1	151
BXRC-30E2000-D-7X-SE	3000	80	500	2415	2173	31.8	15.9	152
BXRC-30G2000-B-7X-SE	3000	90	450	1968	1771	35.0	15.8	125
BXRC-30G2000-C-7X-SE	3000	90	630	2755	2479	35.0	22.1	125
BXRC-30G2000-D-7X-SE	3000	90	500	2004	1803	31.8	15.9	126
BXRC-30H2000-B-7X-SE	3000	97	450	1778	1600	35.0	15.8	113
BXRC-30H2000-C-7X-SE	3000	97	630	2489	2240	35.0	22.1	113
BXRC-30H2000-D-7X-SE	3000	97	500	1811	1630	31.8	15.9	114
BXRC-30A2001-B-73-SE <sup>8,9</sup>	3000	93	450	1836	1652	35.0	15.8	117
BXRC-30A2001-C-73-SE <sup>8,9</sup>	3000	93	630	2570	2313	35.0	22.1	117
BXRC-30A2001-D-73-SE <sup>8,9</sup>	3000	93	500	1869	1683	31.8	15.9	118
BXRC-35E2000-B-7X-SE	3500	80	450	2442	2198	35.0	15.8	155
BXRC-35E2000-C-7X-SE	3500	80	630	3419	3077	35.0	22.1	155
BXRC-35E2000-D-7X-SE	3500	80	500	2487	2238	31.8	15.9	156
BXRC-35G2000-B-7X-SE	3500	90	450	2039	1836	35.0	15.8	129
BXRC-35G2000-C-7X-SE	3500	90	630	2854	2569	35.0	22.1	129
BXRC-35G2000-D-7X-SE	3500	90	500	2076	1869	31.8	15.9	131
BXRC-35A2001-B-73-SE <sup>8,9</sup>	3500	93	450	1974	1776	35.0	15.8	125
BXRC-35A2001-C-73-SE <sup>8,9</sup>	3500	93	630	2763	2486	35.0	22.1	125
BXRC-35A2001-D-73-SE <sup>8,9</sup>	3500	93	500	2009	1808	31.8	15.9	126

Notes for Table 1:

- Nominal CCT as defined by ANSI C78.377-2011. Products with a CCT of 5000K-6500K are hot targeted to  $T_c = 85^\circ\text{C}$ .
- CRI values are typical for Decor Series Ultra and Decor Series Class A products. CRI values are minimums for all other products. Minimum Rg value for 80 CRI products is 0, the minimum Rg values for 90 CRI products is 50, the typical Rg values for 97 CRI products is 98.
- Drive current is referred to as nominal drive current.
- Products tested under pulsed condition (10ms pulse width) at nominal test current where  $T_j$  (junction temperature) =  $T_c$  (case temperature) =  $25^\circ\text{C}$ .
- Typical performance values are provided as a reference only and are not a guarantee of performance.
- Bridgelux maintains a  $\pm 7\%$  tolerance on flux measurements.
- Minimum flux values at the nominal test current are guaranteed by 100% test.
- Nominal CCT is defined by the Lighting Research Center's Class A definition. The center of the Class A color bin is on the corresponding isothermal line.
- GAI value is 80. To help ensure optimal fixture level performance, GAI is measured at the fixture level, on axis, at a case temperature of  $70^\circ\text{C}$ . GAI may vary depending on fixture design and performance.

# Product Selection Guide

**Table 1:** Selection Guide, Pulsed Measurement Data ( $T_j = T_c = 25^\circ\text{C}$ ) (continued)

Part Number	Nominal CCT <sup>1</sup> (K)	CRI <sup>2</sup>	Nominal Drive Current <sup>3</sup> (mA)	Typical Pulsed Flux <sup>4,5,6</sup> $T_c = 25^\circ\text{C}$ (lm)	Minimum Pulsed Flux <sup>6,7</sup> $T_c = 25^\circ\text{C}$ (lm)	Typical $V_f$ (V)	Typical Power (W)	Typical Efficacy (lm/W)
BXRC-40E2000-B-7X-SE	4000	80	450	2466	2220	35.0	15.8	157
BXRC-40E2000-C-7X-SE	4000	80	630	3452	3107	35.0	22.1	157
BXRC-40E2000-D-7X-SE	4000	80	500	2511	2260	31.8	15.9	158
BXRC-40G2000-B-7X-SE	4000	90	450	2110	1899	35.0	15.8	134
BXRC-40G2000-C-7X-SE	4000	90	630	2954	2659	35.0	22.1	134
BXRC-40G2000-D-7X-SE	4000	90	500	2149	1934	31.8	15.9	135
BXRC-40A2001-B-73-SE <sup>8,9</sup>	4000	93	450	2111	1900	35.0	15.8	134
BXRC-40A2001-C-73-SE <sup>8,9</sup>	4000	93	630	2955	2660	35.0	22.1	134
BXRC-40A2001-D-73-SE <sup>8,9</sup>	4000	93	500	2150	1936	31.8	15.9	135
BXRC-50C2001-B-74-SE	5000	70	450	2703	2432	35.0	15.8	172
BXRC-50C2001-C-74-SE	5000	70	630	3784	3406	35.0	22.1	172
BXRC-50C2001-D-74-SE	5000	70	500	2752	2477	31.8	15.9	173
BXRC-50E2001-B-74-SE	5000	80	450	2541	2287	35.0	15.8	161
BXRC-50E2001-C-74-SE	5000	80	630	3557	3201	35.0	22.1	161
BXRC-50E2001-D-74-SE	5000	80	500	2587	2328	31.8	15.9	163
BXRC-50G2001-B-74-SE	5000	90	450	2162	1946	35.0	15.8	137
BXRC-50G2001-C-74-SE	5000	90	630	3027	2724	35.0	22.1	137
BXRC-50G2001-D-74-SE	5000	90	500	2202	1982	31.8	15.9	138
BXRC-57C2001-B-74-SE	5700	70	450	2608	2347	35.0	15.8	166
BXRC-57C2001-C-74-SE	5700	70	630	3651	3286	35.0	22.1	166
BXRC-57C2001-D-74-SE	5700	70	500	2656	2390	31.8	15.9	167
BXRC-57E2001-B-74-SE	5700	80	450	2585	2327	35.0	15.8	164
BXRC-57E2001-C-74-SE	5700	80	630	3618	3256	35.0	22.1	164
BXRC-57E2001-D-74-SE	5700	80	500	2632	2369	31.8	15.9	166
BXRC-65C2001-B-74-SE	6500	70	450	2656	2390	35.0	15.8	169
BXRC-65C2001-C-74-SE	6500	70	630	3717	3346	35.0	22.1	169
BXRC-65C2001-D-74-SE	6500	70	500	2704	2433	31.8	15.9	170
BXRC-65E2001-B-74-SE	6500	80	450	2632	2369	35.0	15.8	167
BXRC-65E2001-C-74-SE	6500	80	630	3684	3315	35.0	22.1	167
BXRC-65E2001-D-74-SE	6500	80	500	2680	2412	31.8	15.9	169

Notes for Table 1:

- Nominal CCT as defined by ANSI C78.377-2011. Products with a CCT of 5000K-6500K are hot targeted to  $T_c = 85^\circ\text{C}$ .
- CRI values are typical for Decor Series Ultra and Decor Series Class A products. CRI values are minimums for all other products. Minimum Rg value for 80 CRI products is 0, the minimum Rg values for 90 CRI products is 50, the typical Rg values for 97 CRI products is 98.
- Drive current is referred to as nominal drive current.
- Products tested under pulsed condition (10ms pulse width) at nominal test current where  $T_j$  (junction temperature) -  $T_c$  (case temperature) =  $25^\circ\text{C}$ .
- Typical performance values are provided as a reference only and are not a guarantee of performance.
- Bridgelux maintains a  $\pm 7\%$  tolerance on flux measurements.
- Minimum flux values at the nominal test current are guaranteed by 100% test.
- Nominal CCT is defined by the Lighting Research Center's Class A definition. The center of the Class A color bin is on the corresponding isothermal line.
- GAI value is 80. To help ensure optimal fixture level performance, GAI is measured at the fixture level, on axis, at a case temperature of  $70^\circ\text{C}$ . GAI may vary depending on fixture design and performance.

# Product Selection Guide

**Table 2:** Selection Guide, Stabilized DC Performance ( $T_c = 70^\circ\text{C}$ ) <sup>7,8</sup>

Part Number	Nominal CCT <sup>1</sup> (K)	GAI <sup>2</sup>	CRI <sup>3</sup>	Nominal Drive Current <sup>4</sup> (mA)	Typical DC Flux <sup>5,6</sup> $T_c = 70^\circ\text{C}$ (lm)	Minimum DC Flux <sup>6,9</sup> $T_c = 70^\circ\text{C}$ (lm)	Typical $V_f$ (V)	Typical Power (W)	Typical Efficacy (lm/W)
BXRC-30A2001-B-73	3000	80	93	450	1707	1537	34.4	15.5	110
BXRC-30A2001-C-73	3000	80	93	630	2390	2151	34.4	21.6	110
BXRC-30A2001-D-73	3000	80	93	500	1738	1565	31.2	15.6	111
BXRC-35A2001-B-73	3500	80	93	450	1836	1651	34.4	15.5	119
BXRC-35A2001-C-73	3500	80	93	630	2569	2312	34.4	21.6	119
BXRC-35A2001-D-73	3500	80	93	500	1868	1682	31.2	15.6	120
BXRC-40A2001-B-73	4000	80	93	450	1963	1767	34.4	15.5	127
BXRC-40A2001-C-73	4000	80	93	630	2748	2474	34.4	21.6	127
BXRC-40A2001-D-73	4000	80	93	500	2000	1800	31.2	15.6	128

Notes for Table 2:

- Nominal CCT is defined by the Lighting Research Center's Class A definition. The center of the Class A color bin is on the corresponding isothermal line.
- To help ensure optimal fixture level performance, GAI is measured at the fixture level, on axis, at a case temperature of  $70^\circ\text{C}$ . GAI may vary depending on fixture design and performance.
- CRI Values are specified as typical.
- Drive current is referred to as nominal drive current.
- Typical performance values are provided as a reference only and are not a guarantee of performance.
- Bridgelux maintains a  $\pm 7\%$  tolerance on flux measurements.
- Typical stabilized DC performance values are provided as reference only and are not a guarantee of performance.
- Typical performance is estimated based on operation under DC (direct current) with LED array mounted onto a heat sink with thermal interface material and the case temperature maintained at specified temperature. Based on Bridgelux test setup, values may vary depending on the thermal design of the luminaire and/or the exposed environment to which the product is subjected.
- Minimum flux values at elevated temperatures are provided for reference only and are not guaranteed by 100% production testing. Based on Bridgelux test setup, values may vary depending on the thermal design of the luminaire and/or the exposed environment to which the product is subjected.

# Product Selection Guide

**Table 3:** Selection Guide, Stabilized DC Performance ( $T_c = 85^\circ\text{C}$ )<sup>4,5</sup>

Part Number	Nominal CCT <sup>1</sup> (K)	CRI <sup>2</sup>	Nominal Drive Current <sup>3</sup> (mA)	Typical DC Flux <sup>4,5</sup> $T_c = 85^\circ\text{C}$ (lm)	Minimum DC Flux <sup>6</sup> $T_c = 85^\circ\text{C}$ (lm)	Typical $V_f$ (V)	Typical Power (W)	Typical Efficacy (lm/W)
BXRC-27E2000-B-7X-SE	2700	80	450	2049	1843	34.1	15.3	133
BXRC-27E2000-C-7X-SE	2700	80	630	2868	2581	34.1	21.5	133
BXRC-27E2000-D-7X-SE	2700	80	500	2086	1878	30.9	15.5	135
BXRC-27G2000-B-7X-SE	2700	90	450	1707	1536	34.1	15.3	111
BXRC-27G2000-C-7X-SE	2700	90	630	2390	2150	34.1	21.5	111
BXRC-27G2000-D-7X-SE	2700	90	500	1738	1565	30.9	15.5	112
BXRC-27H2000-B-7X-SE	2700	97	450	1498	1349	34.1	15.3	98
BXRC-27H2000-C-7X-SE	2700	97	630	2097	1887	34.1	21.5	98
BXRC-27H2000-D-7X-SE	2700	97	500	1526	1373	30.9	15.5	99
BXRC-30E2000-B-7X-SE	3000	80	450	2134	1921	34.1	15.3	139
BXRC-30E2000-C-7X-SE	3000	80	630	2987	2688	34.1	21.5	139
BXRC-30E2000-D-7X-SE	3000	80	500	2173	1955	30.9	15.5	141
BXRC-30G2000-B-7X-SE	3000	90	450	1771	1594	34.1	15.3	115
BXRC-30G2000-C-7X-SE	3000	90	630	2479	2231	34.1	21.5	115
BXRC-30G2000-D-7X-SE	3000	90	500	1804	1623	30.9	15.5	117
BXRC-30H2000-B-7X-SE	3000	97	450	1600	1440	34.1	15.3	104
BXRC-30H2000-C-7X-SE	3000	97	630	2240	2016	34.1	21.5	104
BXRC-30H2000-D-7X-SE	3000	97	500	1630	1467	30.9	15.5	105
BXRC-30A2001-B-73-SE <sup>7,8</sup>	3000	93	450	1652	1487	34.1	15.3	108
BXRC-30A2001-C-73-SE <sup>7,8</sup>	3000	93	630	2313	2082	34.1	21.5	108
BXRC-30A2001-D-73-SE <sup>7,8</sup>	3000	93	500	1682	1514	30.9	15.5	109
BXRC-35E2000-B-7X-SE	3500	80	450	2198	1978	34.1	15.3	143
BXRC-35E2000-C-7X-SE	3500	80	630	3077	2769	34.1	21.5	143
BXRC-35E2000-D-7X-SE	3500	80	500	2238	2014	30.9	15.5	145
BXRC-35G2000-B-7X-SE	3500	90	450	1835	1652	34.1	15.3	120
BXRC-35G2000-C-7X-SE	3500	90	630	2569	2312	34.1	21.5	120
BXRC-35G2000-D-7X-SE	3500	90	500	1869	1682	30.9	15.5	121
BXRC-35A2001-B-73-SE <sup>7,8</sup>	3500	93	450	1776	1598	34.1	15.3	116
BXRC-35A2001-C-73-SE <sup>7,8</sup>	3500	93	630	2486	2238	34.1	21.5	116
BXRC-35A2001-D-73-SE <sup>7,8</sup>	3500	93	500	1808	1627	30.9	15.5	117

Notes for Table 3:

- Nominal CCT as defined by ANSI C78.377-2011. Products with a CCT of 5000K-6500K are hot targeted to  $T_c = 85^\circ\text{C}$ .
- CRI values are typical for Decor Series Ultra and Decor Series Class A products. CRI values are minimums for all other products. Minimum Rg value for 80 CRI products is 0, the minimum Rg values for 90 CRI products is 50, the typical Rg values for 97 CRI products is 98.
- Drive current is referred to as nominal drive current.
- Typical stabilized DC performance values are provided as reference only and are not a guarantee of performance.
- Typical performance is estimated based on operation under DC (direct current) with LED array mounted onto a heat sink with thermal interface material and the case temperature maintained at  $85^\circ\text{C}$ . Based on Bridgelux test setup, values may vary depending on the thermal design of the luminaire and/or the exposed environment to which the product is subjected.
- Minimum flux values at elevated temperatures are provided for reference only and are not guaranteed by 100% production testing. Based on Bridgelux test setup, values may vary depending on the thermal design of the luminaire and/or the exposed environment to which the product is subjected.
- Nominal CCT is defined by the Lighting Research Center's Class A definition. The center of the Class A color bin is on the corresponding isothermal line.
- GAI value is 80. To help ensure optimal fixture level performance, GAI is measured at the fixture level, on axis, at a case temperature of  $70^\circ\text{C}$ . GAI may vary depending on fixture design and performance.



# Product Selection Guide

**Table 3:** Selection Guide, Stabilized DC Performance ( $T_c = 85^\circ\text{C}$ )<sup>4,5</sup> (continued)

Part Number	Nominal CCT <sup>1</sup> (K)	CRI <sup>2</sup>	Nominal Drive Current <sup>3</sup> (mA)	Typical DC Flux <sup>4,5</sup> $T_c = 85^\circ\text{C}$ (lm)	Minimum DC Flux <sup>6</sup> $T_c = 85^\circ\text{C}$ (lm)	Typical $V_f$ (V)	Typical Power (W)	Typical Efficacy (lm/W)
BXRC-40E2000-B-7X-SE	4000	80	450	2219	1998	34.1	15.3	145
BXRC-40E2000-C-7X-SE	4000	80	630	3107	2796	34.1	21.5	145
BXRC-40E2000-D-7X-SE	4000	80	500	2260	2034	30.9	15.5	146
BXRC-40G2000-B-7X-SE	4000	90	450	1899	1709	34.1	15.3	124
BXRC-40G2000-C-7X-SE	4000	90	630	2659	2393	34.1	21.5	124
BXRC-40G2000-D-7X-SE	4000	90	500	1934	1740	30.9	15.5	125
BXRC-40A2001-B-73-SE <sup>7,8</sup>	4000	93	450	1900	1710	34.1	15.3	124
BXRC-40A2001-C-73-SE <sup>7,8</sup>	4000	93	630	2659	2394	34.1	21.5	124
BXRC-40A2001-D-73-SE <sup>7,8</sup>	4000	93	500	1935	1742	30.9	15.5	125
BXRC-50C2001-B-74-SE	5000	70	450	2433	2189	34.1	15.3	159
BXRC-50C2001-C-74-SE	5000	70	630	3405	3065	34.1	21.5	158
BXRC-50C2001-D-74-SE	5000	70	500	2477	2230	30.9	15.5	160
BXRC-50E2001-B-74-SE	5000	80	450	2287	2059	34.1	15.3	149
BXRC-50E2001-C-74-SE	5000	80	630	3201	2881	34.1	21.5	149
BXRC-50E2001-D-74-SE	5000	80	500	2329	2096	30.9	15.5	151
BXRC-50G2001-B-74-SE	5000	90	450	1946	1752	34.1	15.3	127
BXRC-50G2001-C-74-SE	5000	90	630	2724	2452	34.1	21.5	127
BXRC-50G2001-D-74-SE	5000	90	500	1982	1783	30.9	15.5	128
BXRC-57C2001-B-74-SE	5700	70	450	2347	2112	34.1	15.3	153
BXRC-57C2001-C-74-SE	5700	70	630	3286	2957	34.1	21.5	153
BXRC-57C2001-D-74-SE	5700	70	500	2390	2151	30.9	15.5	155
BXRC-57E2001-B-74-SE	5700	80	450	2326	2094	34.1	15.3	152
BXRC-57E2001-C-74-SE	5700	80	630	3256	2930	34.1	21.5	152
BXRC-57E2001-D-74-SE	5700	80	500	2369	2132	30.9	15.5	153
BXRC-65C2001-B-74-SE	6500	70	450	2390	2151	34.1	15.3	156
BXRC-65C2001-C-74-SE	6500	70	630	3346	3011	34.1	21.5	156
BXRC-65C2001-D-74-SE	6500	70	500	2434	2190	30.9	15.5	157
BXRC-65E2001-B-74-SE	6500	80	450	2369	2132	34.1	15.3	154
BXRC-65E2001-C-74-SE	6500	80	630	3316	2984	34.1	21.5	154
BXRC-65E2001-D-74-SE	6500	80	500	2412	2171	30.9	15.5	156

Notes for Table 3:

- Nominal CCT as defined by ANSI C78.377-2011. Products with a CCT of 5000K-6500K are hot targeted to  $T_c = 85^\circ\text{C}$ .
- CRI values are typical for Decor Series Ultra and Decor Series Class A products. CRI values are minimums for all other products. Minimum R<sub>g</sub> value for 80 CRI products is 0, the minimum R<sub>g</sub> values for 90 CRI products is 50, the typical R<sub>g</sub> values for 97 CRI products is 98.
- Drive current is referred to as nominal drive current.
- Typical stabilized DC performance values are provided as reference only and are not a guarantee of performance.
- Typical performance is estimated based on operation under DC (direct current) with LED array mounted onto a heat sink with thermal interface material and the case temperature maintained at  $85^\circ\text{C}$ . Based on Bridgelux test setup, values may vary depending on the thermal design of the luminaire and/or the exposed environment to which the product is subjected.
- Minimum flux values at elevated temperatures are provided for reference only and are not guaranteed by 100% production testing. Based on Bridgelux test setup, values may vary depending on the thermal design of the luminaire and/or the exposed environment to which the product is subjected.
- Nominal CCT is defined by the Lighting Research Center's Class A definition. The center of the Class A color bin is on the corresponding isothermal line.
- GAI value is 80. To help ensure optimal fixture level performance, GAI is measured at the fixture level, on axis, at a case temperature of  $70^\circ\text{C}$ . GAI may vary depending on fixture design and performance.

# Performance at Commonly Used Drive Currents

Vero SE LED arrays are tested to the specifications shown using the nominal drive currents in Table 1. Vero SE may also be driven at other drive currents dependent on specific application design requirements. The performance at any drive current can be derived from the current vs. voltage characteristics shown in Figures 1, 2 & 3 and the flux vs. current characteristics shown in Figures 4, 5 & 6. The performance at commonly used drive currents is summarized in Table 4.

**Table 4:** Product Performance at Commonly Used Drive Currents

Part Number	CRI	Drive Current <sup>1</sup> (mA)	Typical $V_f$ $T_c = 25^\circ\text{C}$ (V)	Typical Power $T_c = 25^\circ\text{C}$ (W)	Typical Flux <sup>2</sup> $T_c = 25^\circ\text{C}$ (lm)	Typical DC Flux <sup>3</sup> $T_c = 85^\circ\text{C}$ (lm)	Typical Efficacy $T_c = 25^\circ\text{C}$ (lm/W)
BXRC-27E2000-B-7X-SE	80	113	32.3	3.6	620	568	171
		225	33.2	7.5	1200	1088	161
		<b>450</b>	<b>35.0</b>	<b>15.8</b>	<b>2276</b>	<b>2049</b>	<b>145</b>
		675	36.3	24.5	3290	2881	134
		900	37.5	33.7	4196	3604	124
BXRC-27E2000-C-7X-SE	80	158	32.3	5.1	861	814	169
		315	33.2	10.5	1667	1569	159
		<b>630</b>	<b>35.0</b>	<b>22.1</b>	<b>3186</b>	<b>2868</b>	<b>145</b>
		945	36.4	34.4	4573	4275	133
		1260	37.8	47.6	5837	5439	123
BXRC-27E2000-D-7X-SE	80	125	29.6	3.7	614	586	166
		250	30.3	7.6	1189	1133	157
		<b>500</b>	<b>31.8</b>	<b>15.9</b>	<b>2318</b>	<b>2086</b>	<b>146</b>
		750	33.2	24.9	3276	3103	132
		1000	34.4	34.4	4188	3958	122
BXRC-27G2000-B-7X-SE	90	113	32.3	3.6	517	473	142
		225	33.2	7.5	1000	907	134
		<b>450</b>	<b>35.0</b>	<b>15.8</b>	<b>1897</b>	<b>1707</b>	<b>120</b>
		675	36.3	24.5	2741	2401	112
		900	37.5	33.7	3497	3004	104
BXRC-27G2000-C-7X-SE	90	158	32.3	5.1	717	678	141
		315	33.2	10.5	1389	1308	133
		<b>630</b>	<b>35.0</b>	<b>22.1</b>	<b>2655</b>	<b>2390</b>	<b>120</b>
		945	36.4	34.4	3811	3563	111
		1260	37.8	47.6	4864	4532	102
BXRC-27G2000-D-7X-SE	90	125	29.6	3.7	511	488	138
		250	30.3	7.6	991	944	131
		<b>500</b>	<b>31.8</b>	<b>15.9</b>	<b>1932</b>	<b>1738</b>	<b>121</b>
		750	33.2	24.9	2730	2586	110
		1000	34.4	34.4	3490	3298	101

Notes for Table 4:

1. Alternate drive currents are provided for reference only and are not a guarantee of performance.
2. Bridgelux maintains a  $\pm 7\%$  tolerance on flux measurements.
3. Typical stabilized DC performance values are provided as reference only and are not a guarantee of performance.

# Performance at Commonly Used Drive Currents

**Table 4:** Product Performance at Commonly Used Drive Currents (Continued)

Part Number	CRI	Drive Current <sup>1</sup> (mA)	Typical V <sub>f</sub> T <sub>c</sub> = 25°C (V)	Typical Power T <sub>c</sub> = 25°C (W)	Typical Flux <sup>2</sup> T <sub>c</sub> = 25°C (lm)	Typical DC Flux <sup>3</sup> T <sub>c</sub> = 85°C (lm)	Typical Efficacy T <sub>c</sub> = 25°C (lm/W)
BXRC-27H2000-B-7X-SE	80	113	32.3	3.6	453	415	125
		225	33.2	7.5	877	796	117
		<b>450</b>	<b>35.0</b>	<b>15.8</b>	<b>1664</b>	<b>1498</b>	<b>106</b>
		675	36.3	24.5	2405	2106	98
		900	37.5	33.7	3068	2635	91
BXRC-27H2000-C-7X-SE	80	158	32.3	5.1	629	595	124
		315	33.2	10.5	1218	1147	116
		<b>630</b>	<b>35.0</b>	<b>22.1</b>	<b>2330</b>	<b>2097</b>	<b>106</b>
		945	36.4	34.4	3344	3126	97
		1260	37.8	47.6	4267	3976	90
BXRC-27H2000-D-7X-SE	80	125	29.6	3.7	449	429	121
		250	30.3	7.6	870	829	115
		<b>500</b>	<b>31.8</b>	<b>15.9</b>	<b>1695</b>	<b>1526</b>	<b>107</b>
		750	33.2	24.9	2396	2269	96
		1000	34.4	34.4	3063	2895	89
BXRC-30E2000-B-7X-SE	80	113	32.3	3.6	646	592	178
		225	33.2	7.5	1250	1134	167
		<b>450</b>	<b>35.0</b>	<b>15.8</b>	<b>2372</b>	<b>2134</b>	<b>151</b>
		675	36.3	24.5	3427	3001	140
		900	37.5	33.7	4372	3755	130
BXRC-30E2000-C-7X-SE	80	158	32.3	5.1	897	848	176
		315	33.2	10.5	1736	1635	166
		<b>630</b>	<b>35.0</b>	<b>22.1</b>	<b>3319</b>	<b>2987</b>	<b>151</b>
		945	36.4	34.4	4764	4454	138
		1260	37.8	47.6	6080	5666	128
BXRC-30E2000-D-7X-SE	80	125	29.6	3.7	639	610	173
		250	30.3	7.6	1239	1180	163
		<b>500</b>	<b>31.8</b>	<b>15.9</b>	<b>2415</b>	<b>2173</b>	<b>152</b>
		750	33.2	24.9	3412	3233	137
		1000	34.4	34.4	4363	4123	127
BXRC-30G2000-B-7X-SE	90	113	32.3	3.6	536	491	147
		225	33.2	7.5	1037	941	139
		<b>450</b>	<b>35.0</b>	<b>15.8</b>	<b>1968</b>	<b>1771</b>	<b>125</b>
		675	36.3	24.5	2844	2491	116
		900	37.5	33.7	3628	3116	108
BXRC-30G2000-C-7X-SE	90	158	32.3	5.1	744	704	146
		315	33.2	10.5	1441	1357	138
		<b>630</b>	<b>35.0</b>	<b>22.1</b>	<b>2755</b>	<b>2479</b>	<b>125</b>
		945	36.4	34.4	3954	3696	115
		1260	37.8	47.6	5046	4702	106
BXRC-30G2000-D-7X-SE	90	125	29.6	3.7	530	507	144
		250	30.3	7.6	1028	979	136
		<b>500</b>	<b>31.8</b>	<b>15.9</b>	<b>2004</b>	<b>1804</b>	<b>126</b>
		750	33.2	24.9	2832	2683	114
		1000	34.4	34.4	3621	3422	105

Notes for Table 4:

1. Alternate drive currents are provided for reference only and are not a guarantee of performance.
2. Bridgelux maintains a ± 7% tolerance on flux measurements.
3. Typical stabilized DC performance values are provided as reference only and are not a guarantee of performance.

# Performance at Commonly Used Drive Currents

**Table 4:** Product Performance at Commonly Used Drive Currents (Continued)

Part Number	CRI	Drive Current <sup>1</sup> (mA)	Typical V <sub>f</sub> T <sub>c</sub> = 25°C (V)	Typical Power T <sub>c</sub> = 25°C (W)	Typical Flux <sup>2</sup> T <sub>c</sub> = 25°C (lm)	Typical DC Flux <sup>3</sup> T <sub>c</sub> = 85°C (lm)	Typical Efficacy T <sub>c</sub> = 25°C (lm/W)
BXRC-30H2000-B-7X-SE	80	113	32.3	3.6	484	444	133
		225	33.2	7.5	937	850	125
		<b>450</b>	<b>35.0</b>	<b>15.8</b>	<b>1778</b>	<b>1600</b>	<b>113</b>
		675	36.3	24.5	2570	2250	105
		900	37.5	33.7	3278	2816	97
BXRC-30H2000-C-7X-SE	80	158	32.3	5.1	673	636	132
		315	33.2	10.5	1302	1226	124
		<b>630</b>	<b>35.0</b>	<b>22.1</b>	<b>2489</b>	<b>2240</b>	<b>113</b>
		945	36.4	34.4	3572	3340	104
		1260	37.8	47.6	4560	4248	96
BXRC-30H2000-D-7X-SE	80	125	29.6	3.7	479	458	130
		250	30.3	7.6	929	885	123
		<b>500</b>	<b>31.8</b>	<b>15.9</b>	<b>1811</b>	<b>1630</b>	<b>114</b>
		750	33.2	24.9	2559	2424	103
		1000	34.4	34.4	3272	3092	95
BXRC-30A2001-B-73-SE	93	113	32.3	3.6	500	458	137
		225	33.2	7.5	968	878	129
		<b>450</b>	<b>35.0</b>	<b>15.8</b>	<b>1836</b>	<b>1652</b>	<b>117</b>
		675	36.3	24.5	2653	2323	108
		900	37.5	33.7	3384	2906	100
BXRC-30A2001-C-73-SE	93	158	32.3	5.1	694	656	136
		315	33.2	10.5	1344	1266	128
		<b>630</b>	<b>35.0</b>	<b>22.1</b>	<b>2570</b>	<b>2313</b>	<b>117</b>
		945	36.4	34.4	3688	3448	107
		1260	37.8	47.6	4707	4386	99
BXRC-30A2001-D-73-SE	93	125	29.6	3.7	495	472	134
		250	30.3	7.6	959	913	126
		<b>500</b>	<b>31.8</b>	<b>15.9</b>	<b>1869</b>	<b>1682</b>	<b>118</b>
		750	33.2	24.9	2641	2502	106
		1000	34.4	34.4	3377	3191	98
BXRC-35E2000-B-7X-SE	80	113	32.3	3.6	665	610	183
		225	33.2	7.5	1287	1168	172
		<b>450</b>	<b>35.0</b>	<b>15.8</b>	<b>2442</b>	<b>2198</b>	<b>155</b>
		675	36.3	24.5	3529	3091	144
		900	37.5	33.7	4502	3867	133
BXRC-35E2000-C-7X-SE	80	158	32.3	5.1	924	873	181
		315	33.2	10.5	1788	1684	171
		<b>630</b>	<b>35.0</b>	<b>22.1</b>	<b>3419</b>	<b>3077</b>	<b>155</b>
		945	36.4	34.4	4907	4587	143
		1260	37.8	47.6	6262	5835	132
BXRC-35E2000-D-7X-SE	80	125	29.6	3.7	658	629	178
		250	30.3	7.6	1276	1215	168
		<b>500</b>	<b>31.8</b>	<b>15.9</b>	<b>2487</b>	<b>2238</b>	<b>156</b>
		750	33.2	24.9	3514	3329	141
		1000	34.4	34.4	4494	4246	131

Notes for Table 4:

1. Alternate drive currents are provided for reference only and are not a guarantee of performance.
2. Bridgelux maintains a ± 7% tolerance on flux measurements.
3. Typical stabilized DC performance values are provided as reference only and are not a guarantee of performance.

# Performance at Commonly Used Drive Currents

**Table 4:** Product Performance at Commonly Used Drive Currents (Continued)

Part Number	CRI	Drive Current <sup>1</sup> (mA)	Typical V <sub>f</sub> T <sub>c</sub> = 25°C (V)	Typical Power T <sub>c</sub> = 25°C (W)	Typical Flux <sup>2</sup> T <sub>c</sub> = 25°C (lm)	Typical DC Flux <sup>3</sup> T <sub>c</sub> = 85°C (lm)	Typical Efficacy T <sub>c</sub> = 25°C (lm/W)
BXRC-35G2000-B-7X-SE	90	113	32.3	3.6	555	509	153
		225	33.2	7.5	1075	975	144
		<b>450</b>	<b>35.0</b>	<b>15.8</b>	<b>2039</b>	<b>1835</b>	<b>129</b>
		675	36.3	24.5	2947	2581	120
		900	37.5	33.7	3759	3229	111
BXRC-35G2000-C-7X-SE	90	158	32.3	5.1	771	729	151
		315	33.2	10.5	1493	1406	143
		<b>630</b>	<b>35.0</b>	<b>22.1</b>	<b>2854</b>	<b>2569</b>	<b>129</b>
		945	36.4	34.4	4097	3830	119
		1260	37.8	47.6	5229	4872	110
BXRC-35G2000-D-7X-SE	90	125	29.6	3.7	550	525	149
		250	30.3	7.6	1066	1015	140
		<b>500</b>	<b>31.8</b>	<b>15.9</b>	<b>2076</b>	<b>1869</b>	<b>131</b>
		750	33.2	24.9	2934	2780	118
		1000	34.4	34.4	3752	3545	109
BXRC-35A2001-B-73-SE	93	113	32.3	3.6	538	493	148
		225	33.2	7.5	1040	944	139
		<b>450</b>	<b>35.0</b>	<b>15.8</b>	<b>1974</b>	<b>1776</b>	<b>125</b>
		675	36.3	24.5	2852	2498	117
		900	37.5	33.7	3638	3125	108
BXRC-35A2001-C-73-SE	93	158	32.3	5.1	746	706	147
		315	33.2	10.5	1445	1361	138
		<b>630</b>	<b>35.0</b>	<b>22.1</b>	<b>2763</b>	<b>2486</b>	<b>125</b>
		945	36.4	34.4	3965	3707	115
		1260	37.8	47.6	5061	4715	106
BXRC-35A2001-D-73-SE	93	125	29.6	3.7	532	508	144
		250	30.3	7.6	1031	982	136
		<b>500</b>	<b>31.8</b>	<b>15.9</b>	<b>2009</b>	<b>1808</b>	<b>126</b>
		750	33.2	24.9	2839	2690	114
		1000	34.4	34.4	3630	3430	105
BXRC-40E2000-B-7X-SE	80	113	32.3	3.6	672	615	185
		225	33.2	7.5	1300	1179	174
		<b>450</b>	<b>35.0</b>	<b>15.8</b>	<b>2466</b>	<b>2219</b>	<b>157</b>
		675	36.3	24.5	3564	3121	146
		900	37.5	33.7	4546	3905	135
BXRC-40E2000-C-7X-SE	80	158	32.3	5.1	933	882	183
		315	33.2	10.5	1805	1700	172
		<b>630</b>	<b>35.0</b>	<b>22.1</b>	<b>3452</b>	<b>3107</b>	<b>157</b>
		945	36.4	34.4	4954	4632	144
		1260	37.8	47.6	6323	5892	133
BXRC-40E2000-D-7X-SE	80	125	29.6	3.7	665	635	180
		250	30.3	7.6	1289	1227	170
		<b>500</b>	<b>31.8</b>	<b>15.9</b>	<b>2511</b>	<b>2260</b>	<b>158</b>
		750	33.2	24.9	3548	3362	143
		1000	34.4	34.4	4537	4288	132

Notes for Table 4:

1. Alternate drive currents are provided for reference only and are not a guarantee of performance.
2. Bridgelux maintains a ± 7% tolerance on flux measurements.
3. Typical stabilized DC performance values are provided as reference only and are not a guarantee of performance.

# Performance at Commonly Used Drive Currents

**Table 4:** Product Performance at Commonly Used Drive Currents (Continued)

Part Number	CRI	Drive Current <sup>1</sup> (mA)	Typical $V_f$ $T_c = 25^\circ\text{C}$ (V)	Typical Power $T_c = 25^\circ\text{C}$ (W)	Typical Flux <sup>2</sup> $T_c = 25^\circ\text{C}$ (lm)	Typical DC Flux <sup>3</sup> $T_c = 85^\circ\text{C}$ (lm)	Typical Efficacy $T_c = 25^\circ\text{C}$ (lm/W)
BXRC-40G2000-B-7X-SE	90	113	32.3	3.6	575	527	158
		225	33.2	7.5	1112	1009	149
		<b>450</b>	<b>35.0</b>	<b>15.8</b>	<b>2110</b>	<b>1899</b>	<b>134</b>
		675	36.3	24.5	3050	2671	125
		900	37.5	33.7	3890	3341	115
BXRC-40G2000-C-7X-SE	90	158	32.3	5.1	798	755	157
		315	33.2	10.5	1545	1455	148
		<b>630</b>	<b>35.0</b>	<b>22.1</b>	<b>2954</b>	<b>2659</b>	<b>134</b>
		945	36.4	34.4	4240	3964	123
		1260	37.8	47.6	5411	5042	114
BXRC-40G2000-D-7X-SE	90	125	29.6	3.7	569	543	154
		250	30.3	7.6	1103	1050	145
		<b>500</b>	<b>31.8</b>	<b>15.9</b>	<b>2149</b>	<b>1934</b>	<b>135</b>
		750	33.2	24.9	3037	2877	122
		1000	34.4	34.4	3883	3669	113
BXRC-40A2001-B-73-SE	93	113	32.3	3.6	575	527	158
		225	33.2	7.5	1113	1009	149
		<b>450</b>	<b>35.0</b>	<b>15.8</b>	<b>2111</b>	<b>1900</b>	<b>134</b>
		675	36.3	24.5	3051	2672	125
		900	37.5	33.7	3891	3342	115
BXRC-40A2001-C-73-SE	93	158	32.3	5.1	798	755	157
		315	33.2	10.5	1545	1455	148
		<b>630</b>	<b>35.0</b>	<b>22.1</b>	<b>2955</b>	<b>2659</b>	<b>134</b>
		945	36.4	34.4	4241	3965	123
		1260	37.8	47.6	5413	5043	114
BXRC-40A2001-D-73-SE	93	125	29.6	3.7	569	544	154
		250	30.3	7.6	1103	1051	145
		<b>500</b>	<b>31.8</b>	<b>15.9</b>	<b>2150</b>	<b>1935</b>	<b>135</b>
		750	33.2	24.9	3038	2878	122
		1000	34.4	34.4	3885	3671	113
BXRC-50C2001-B-74-SE	70	113	32.3	3.6	736	675	202
		225	33.2	7.5	1425	1292	191
		<b>450</b>	<b>35.0</b>	<b>15.8</b>	<b>2703</b>	<b>2433</b>	<b>172</b>
		675	36.3	24.5	3906	3421	160
		900	37.5	33.7	4983	4280	148
BXRC-50C2001-C-74-SE	70	158	32.3	5.1	1022	966	201
		315	33.2	10.5	1979	1864	189
		<b>630</b>	<b>35.0</b>	<b>22.1</b>	<b>3784</b>	<b>3405</b>	<b>172</b>
		945	36.4	34.4	5431	5077	158
		1260	37.8	47.6	6931	6458	146
BXRC-50C2001-D-74-SE	70	125	29.6	3.7	729	696	197
		250	30.3	7.6	1412	1345	186
		<b>500</b>	<b>31.8</b>	<b>15.9</b>	<b>2752</b>	<b>2477</b>	<b>173</b>
		750	33.2	24.9	3890	3685	156
		1000	34.4	34.4	4973	4700	144

Notes for Table 4:

1. Alternate drive currents are provided for reference only and are not a guarantee of performance.
2. Bridgelux maintains a  $\pm 7\%$  tolerance on flux measurements.
3. Typical stabilized DC performance values are provided as reference only and are not a guarantee of performance.

# Performance at Commonly Used Drive Currents

**Table 4:** Product Performance at Commonly Used Drive Currents (Continued)

Part Number	CRI	Drive Current <sup>1</sup> (mA)	Typical $V_f$ $T_c = 25^\circ\text{C}$ (V)	Typical Power $T_c = 25^\circ\text{C}$ (W)	Typical Flux <sup>2</sup> $T_c = 25^\circ\text{C}$ (lm)	Typical DC Flux <sup>3</sup> $T_c = 85^\circ\text{C}$ (lm)	Typical Efficacy $T_c = 25^\circ\text{C}$ (lm/W)
BXRC-50E2001-B-74-SE	80	113	32.3	3.6	692	634	190
		225	33.2	7.5	1339	1215	179
		<b>450</b>	<b>35.0</b>	<b>15.8</b>	<b>2541</b>	<b>2287</b>	<b>161</b>
		675	36.3	24.5	3672	3216	150
		900	37.5	33.7	4684	4023	139
BXRC-50E2001-C-74-SE	80	158	32.3	5.1	961	909	189
		315	33.2	10.5	1860	1752	178
		<b>630</b>	<b>35.0</b>	<b>22.1</b>	<b>3557</b>	<b>3201</b>	<b>161</b>
		945	36.4	34.4	5105	4772	148
		1260	37.8	47.6	6515	6071	137
BXRC-50E2001-D-74-SE	80	125	29.6	3.7	685	654	185
		250	30.3	7.6	1328	1265	175
		<b>500</b>	<b>31.8</b>	<b>15.9</b>	<b>2587</b>	<b>2329</b>	<b>163</b>
		750	33.2	24.9	3656	3464	147
		1000	34.4	34.4	4675	4418	136
BXRC-50G2001-B-74-SE	90	113	32.3	3.6	589	540	162
		225	33.2	7.5	1140	1034	153
		<b>450</b>	<b>35.0</b>	<b>15.8</b>	<b>2162</b>	<b>1946</b>	<b>137</b>
		675	36.3	24.5	3125	2737	128
		900	37.5	33.7	3986	3424	118
BXRC-50G2001-C-74-SE	90	158	32.3	5.1	818	773	161
		315	33.2	10.5	1583	1491	151
		<b>630</b>	<b>35.0</b>	<b>22.1</b>	<b>3027</b>	<b>2724</b>	<b>137</b>
		945	36.4	34.4	4345	4062	126
		1260	37.8	47.6	5545	5167	117
BXRC-50G2001-D-74-SE	90	125	29.6	3.7	583	557	158
		250	30.3	7.6	1130	1076	149
		<b>500</b>	<b>31.8</b>	<b>15.9</b>	<b>2202</b>	<b>1982</b>	<b>138</b>
		750	33.2	24.9	3112	2948	125
		1000	34.4	34.4	3979	3760	116
BXRC-57C2001-B-74-SE	70	113	32.3	3.6	710	651	195
		225	33.2	7.5	1375	1247	184
		<b>450</b>	<b>35.0</b>	<b>15.8</b>	<b>2608</b>	<b>2347</b>	<b>166</b>
		675	36.3	24.5	3769	3301	154
		900	37.5	33.7	4808	4130	142
BXRC-57C2001-C-74-SE	70	158	32.3	5.1	986	933	194
		315	33.2	10.5	1910	1798	182
		<b>630</b>	<b>35.0</b>	<b>22.1</b>	<b>3651</b>	<b>3286</b>	<b>166</b>
		945	36.4	34.4	5240	4899	152
		1260	37.8	47.6	6688	6232	141
BXRC-57C2001-D-74-SE	70	125	29.6	3.7	703	671	190
		250	30.3	7.6	1363	1298	180
		<b>500</b>	<b>31.8</b>	<b>15.9</b>	<b>2656</b>	<b>2390</b>	<b>167</b>
		750	33.2	24.9	3753	3556	151
		1000	34.4	34.4	4799	4535	139

Notes for Table 4:

1. Alternate drive currents are provided for reference only and are not a guarantee of performance.
2. Bridgelux maintains a  $\pm 7\%$  tolerance on flux measurements.
3. Typical stabilized DC performance values are provided as reference only and are not a guarantee of performance.

# Performance at Commonly Used Drive Currents

**Table 4:** Product Performance at Commonly Used Drive Currents (Continued)

Part Number	CRI	Drive Current <sup>1</sup> (mA)	Typical $V_f$ $T_c = 25^\circ\text{C}$ (V)	Typical Power $T_c = 25^\circ\text{C}$ (W)	Typical Flux <sup>2</sup> $T_c = 25^\circ\text{C}$ (lm)	Typical DC Flux <sup>3</sup> $T_c = 85^\circ\text{C}$ (lm)	Typical Efficacy $T_c = 25^\circ\text{C}$ (lm/W)
BXRC-57E2001-B-74-SE	80	113	32.3	3.6	704	645	194
		225	33.2	7.5	1362	1236	182
		<b>450</b>	<b>35.0</b>	<b>15.8</b>	<b>2585</b>	<b>2326</b>	<b>164</b>
		675	36.3	24.5	3735	3271	153
		900	37.5	33.7	4764	4092	141
BXRC-57E2001-C-74-SE	80	158	32.3	5.1	977	924	192
		315	33.2	10.5	1892	1782	181
		<b>630</b>	<b>35.0</b>	<b>22.1</b>	<b>3618</b>	<b>3256</b>	<b>164</b>
		945	36.4	34.4	5193	4854	151
		1260	37.8	47.6	6627	6175	139
BXRC-57E2001-D-74-SE	80	125	29.6	3.7	697	665	189
		250	30.3	7.6	1350	1286	178
		<b>500</b>	<b>31.8</b>	<b>15.9</b>	<b>2632</b>	<b>2369</b>	<b>166</b>
		750	33.2	24.9	3719	3523	149
		1000	34.4	34.4	4755	4494	138
BXRC-65C2001-B-74-SE	70	113	32.3	3.6	723	663	199
		225	33.2	7.5	1400	1270	187
		<b>450</b>	<b>35.0</b>	<b>15.8</b>	<b>2656</b>	<b>2390</b>	<b>169</b>
		675	36.3	24.5	3838	3361	157
		900	37.5	33.7	4896	4205	145
BXRC-65C2001-C-74-SE	70	158	32.3	5.1	1004	950	197
		315	33.2	10.5	1944	1831	186
		<b>630</b>	<b>35.0</b>	<b>22.1</b>	<b>3717</b>	<b>3346</b>	<b>169</b>
		945	36.4	34.4	5335	4988	155
		1260	37.8	47.6	6810	6345	143
BXRC-65C2001-D-74-SE	70	125	29.6	3.7	716	684	194
		250	30.3	7.6	1388	1322	183
		<b>500</b>	<b>31.8</b>	<b>15.9</b>	<b>2704</b>	<b>2434</b>	<b>170</b>
		750	33.2	24.9	3821	3620	154
		1000	34.4	34.4	4886	4617	142
BXRC-65E2001-B-74-SE	80	113	32.3	3.6	717	657	197
		225	33.2	7.5	1387	1258	186
		<b>450</b>	<b>35.0</b>	<b>15.8</b>	<b>2632</b>	<b>2369</b>	<b>167</b>
		675	36.3	24.5	3804	3331	155
		900	37.5	33.7	4852	4167	144
BXRC-65E2001-C-74-SE	80	158	32.3	5.1	995	941	195
		315	33.2	10.5	1927	1815	184
		<b>630</b>	<b>35.0</b>	<b>22.1</b>	<b>3684</b>	<b>3316</b>	<b>167</b>
		945	36.4	34.4	5288	4943	154
		1260	37.8	47.6	6749	6288	142
BXRC-65E2001-D-74-SE	80	125	29.6	3.7	709	678	192
		250	30.3	7.6	1375	1310	181
		<b>500</b>	<b>31.8</b>	<b>15.9</b>	<b>2680</b>	<b>2412</b>	<b>169</b>
		750	33.2	24.9	3787	3588	152
		1000	34.4	34.4	4843	4576	141

Notes for Table 4:

1. Alternate drive currents are provided for reference only and are not a guarantee of performance.
2. Bridgelux maintains a  $\pm 7\%$  tolerance on flux measurements.
3. Typical stabilized DC performance values are provided as reference only and are not a guarantee of performance.



# Electrical Characteristics

**Table 5:** Electrical Characteristics

Part Number	Drive Current (mA)	Forward Voltage Pulsed, $T_c = 25^\circ\text{C}$ (V) <sup>1, 2, 3, 8</sup>			Typical Coefficient of Forward Voltage <sup>4</sup> $\Delta V_f / \Delta T_c$ (mV/ $^\circ\text{C}$ )	Typical Thermal Resistance Junction to Case <sup>5,6</sup> $R_{j-c}$ ( $^\circ\text{C}/\text{W}$ )	Driver Selection Voltages <sup>7</sup> (V)	
		Minimum	Typical	Maximum			$V_f$ Min. Hot $T_c = 105^\circ\text{C}$ (V)	$V_f$ Max. Cold $T_c = -40^\circ\text{C}$ (V)
BXRC-xxx200x-B-7x-SE	450	32.4	35.0	37.6	-14.3	0.28	31.2	38.6
	900	34.7	37.5	40.3	-14.3	0.35	33.5	41.2
BXRC-xxx200x-C-7x-SE	630	32.4	35.0	37.6	-14.3	0.20	31.2	38.6
	1260	34.9	37.8	40.6	-14.3	0.24	33.8	41.5
BXRC-xxx200x-D-7x-SE	500	29.4	31.8	34.2	-13.3	0.34	28.4	35.0
	1000	31.8	34.4	37.0	-13.3	0.41	30.8	37.9

Notes for Table 5:

- Parts are tested in pulsed conditions,  $T_c = 25^\circ\text{C}$ . Pulse width is 10ms.
- Voltage minimum and maximum are provided for reference only and are not a guarantee of performance.
- Bridgelux maintains a tester tolerance of  $\pm 0.10\text{V}$  on forward voltage measurements.
- Typical coefficient of forward voltage tolerance is  $\pm 0.1\text{mV}$  for nominal current.
- Thermal resistance values are based from test data of a 3000K 80 CRI product.
- Thermal resistance value was calculated using total electrical input power; optical power was not subtracted from input power. The thermal interface material used during testing is not included in the thermal resistance value.
- $V_f$  min hot and max cold values are provided as reference only and are not guaranteed by test. These values are provided to aid in driver design and selection over the operating range of the product.
- This product has been designed and manufactured per IEC 62031:2014. This product has passed dielectric withstand voltage testing at 1160 V. The working voltage designated for the insulation is 80V d.c. The maximum allowable voltage across the array must be determined in the end product application.

# Eye Safety

**Table 6:** Eye Safety Risk Group (RG) Classifications

Part Number	Drive Current <sup>5</sup> (mA)	CCT <sup>1-5</sup>			
		2700K/3000K	4000K <sup>2</sup>	5000K <sup>3</sup>	6500K <sup>4</sup>
BXRC-xxx200x-B-7x-SE	450	RG1	RG1	RG1	RG1
	675	RG1	RG1	RG1	RG2
	900	RG1	RG1	RG2	RG2
BXRC-xxx200x-C-7x-SE	630	RG1	RG1	RG1	RG1
	945	RG1	RG1	RG2	RG2
	1260	RG1	RG2	RG2	RG2
BXRC-xxx200x-D-7x-SE	500	RG1	RG1	RG1	RG1
	750	RG1	RG1	RG1	RG2
	1000	RG1	RG1	RG2	RG2

Notes for Table 6:

1. Eye safety classification for the use of Bridgelux Vero SE Series LED arrays is in accordance with specification IEC/TR 62778: Application of IEC 62471 for the assessment of blue light hazard to light sources and luminaires.
2. For products classified as RG2 at 4000K,  $E_{thr} = 1847.5$  lx.
3. For products classified as RG2 at 5000K  $E_{thr} = 1315.8$  lx.
4. For products classified as RG2 at 6500K,  $E_{thr} = 1124.5$  lx.
5. Please contact your Bridgelux sales representative for  $E_{thr}$  values at specific drive currents and CCTs not listed.

# Absolute Maximum Ratings

**Table 7:** Maximum Ratings

Parameter	Maximum Rating		
LED Junction Temperature ( $T_j$ )	125°C		
Storage Temperature	-40°C to +105°C		
Operating Case Temperature <sup>1</sup> ( $T_c$ )	105°C		
Soldering Temperature <sup>2</sup>	300°C or lower for a maximum of 6 seconds		
	BXRC-xxx200x-B-7x-SE	BXRC-xxx200x-C-7x-SE	BXRC-xxx200x-D-7x-SE
Maximum Drive Current <sup>3</sup>	900mA	1260mA	1000mA
Maximum Peak Pulsed Drive Current <sup>4</sup>	1290mA	1800mA	1430mA
Maximum Reverse Voltage <sup>5</sup>	-60V	-60V	-55V

Notes for Table 7:

1. For IEC 62717 requirement, please consult your Bridgelux sales representative.
2. Refer to Bridgelux Application Note AN31: Assembly Considerations for Bridgelux Vero LED Arrays.
3. Arrays may be driven at higher currents however lumen maintenance may be reduced.
4. Bridgelux recommends a maximum duty cycle of 10% and pulse width of 20 ms when operating LED Arrays at maximum peak pulsed current specified. Maximum peak pulsed currents indicate values where LED Arrays can be driven without catastrophic failures.
5. Light emitting diodes are not designed to be driven in reverse voltage and will not produce light under this condition. Maximum rating provided for reference only.

# Performance Curves

**Figure 1: Vero SE 13B Drive Current vs. Voltage**

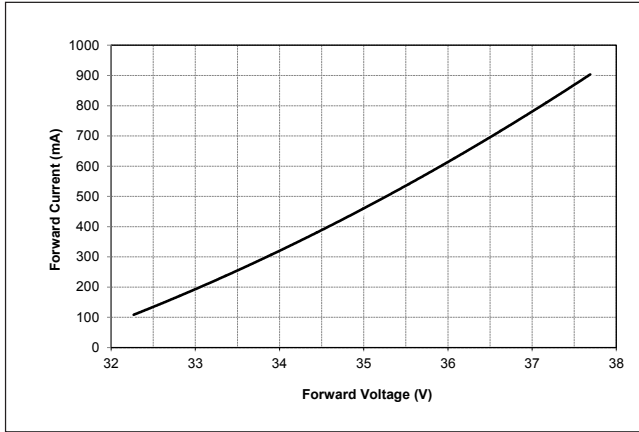

**Figure 2: Vero SE 13C Drive Current vs. Voltage**

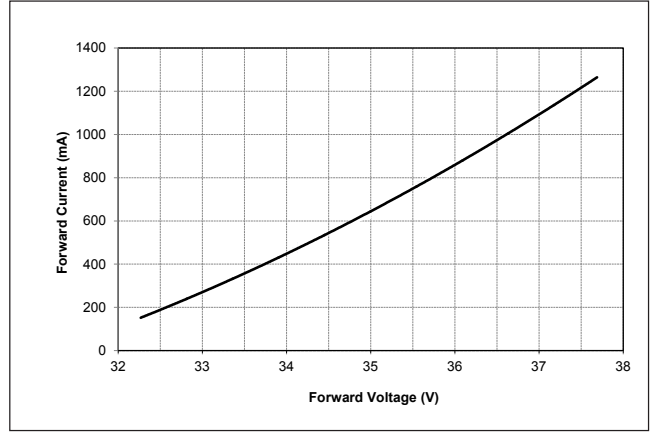

**Figure 3: Vero SE 13D Drive Current vs. Voltage**

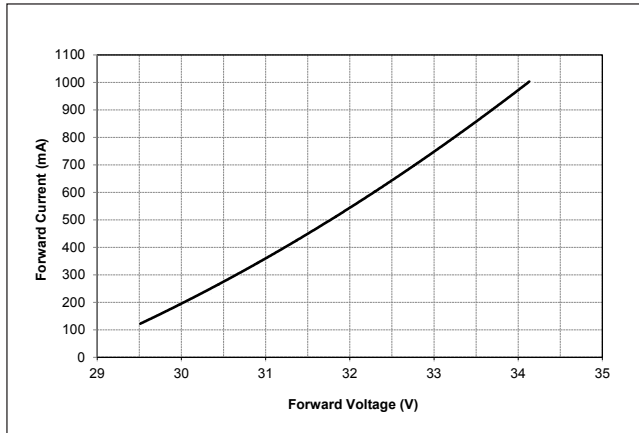

**Figure 4: Vero SE 13B Typical Relative Flux vs. Current**

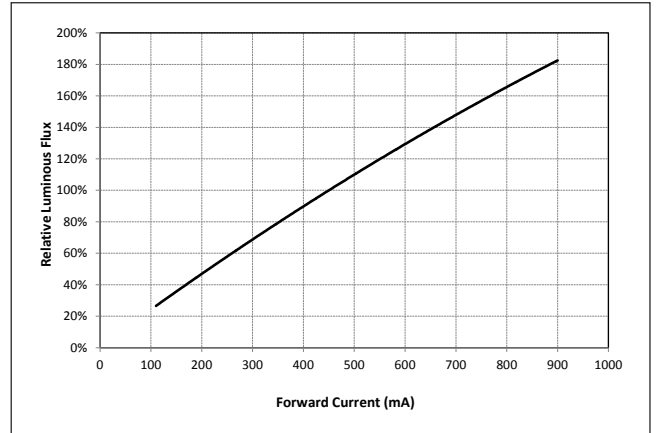

**Figure 5: Vero SE 13C Typical Relative Flux vs. Current**

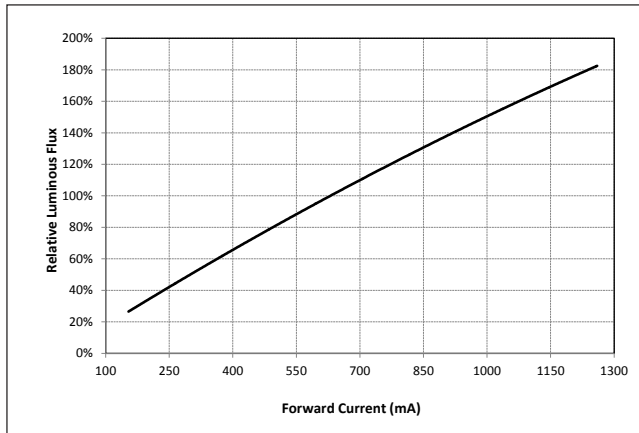

**Figure 6: Vero SE 13D Typical Relative Flux vs. Current**

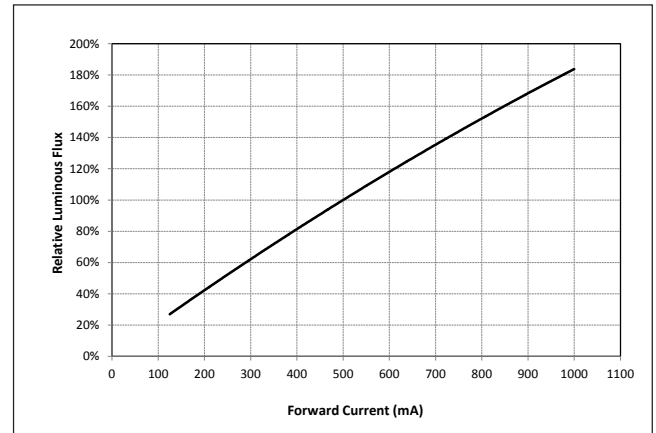

Notes for Figures 1-6:

1. Bridgelux does not recommend driving high power LEDs at low currents. Doing so may produce unpredictable results. Pulse width modulation (PWM) is recommended for dimming effects.
2. Products tested under pulsed condition (10ms pulse width) at nominal test current where  $T_j$  (junction temperature) -  $T_c$  (case temperature) = 25°C.

# Performance Curves

**Figure 7: Typical DC Flux vs. Case Temperature**

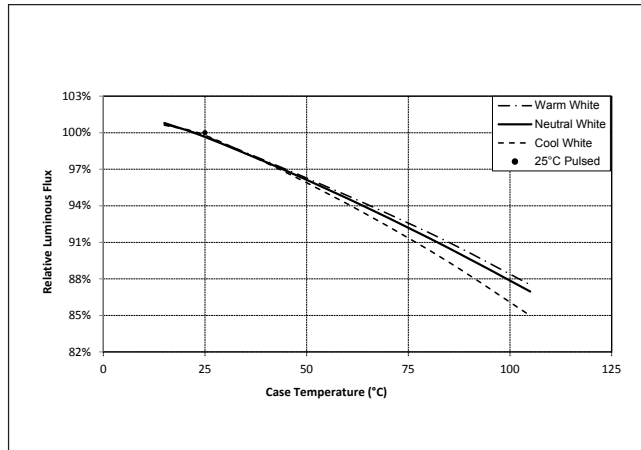

**Figure 8: Décor Series Typical DC Flux vs. Case Temperature<sup>4</sup>**

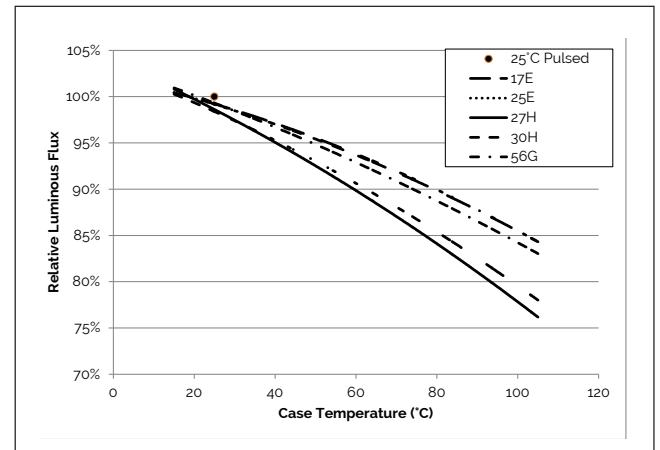

**Figure 9: Typical DC ccy Shift vs. Case Temperature**

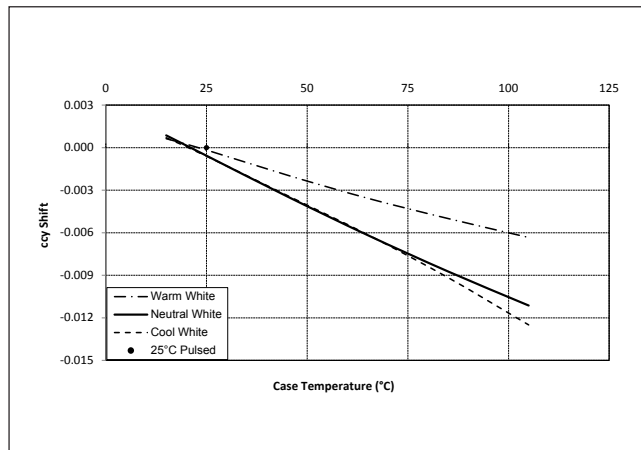

**Figure 10: Typical DC ccx Shift vs. Case Temperature**

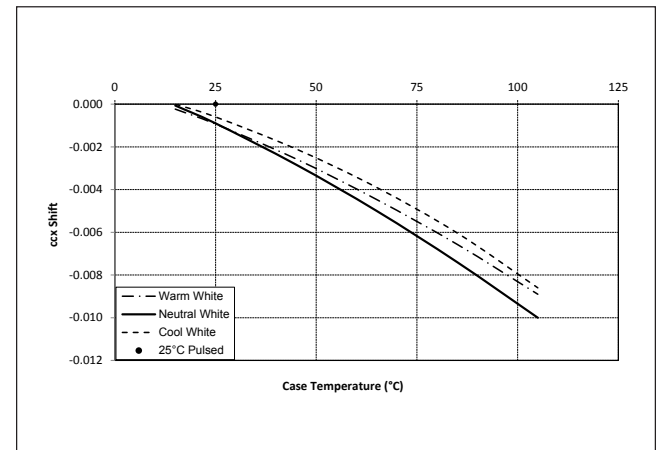

Notes for Figures 7 - 10:

1. Characteristics shown for warm white based on 3000K and 80 CRI.
2. Characteristics shown for neutral white based on 4000K and 80 CRI.
3. Characteristics shown for cool white based on 5000K and 70 CRI.
4. Characteristics shown for 17E based on 1750K and 80 CRI, 25E based on 2500K and 80 CRI, 27H based on 2700K and 97 CRI, 30H based on 3000K and 97 CRI, and 56G based on 5600K and 80 CRI.
5. For other color SKUs, the shift in color will vary. Please contact your Bridgelux Sales Representative for more information.

# Performance Curves

**Figure 11: 2700K, 97 CRI Color Shift vs. Case Temperature<sup>1</sup>**

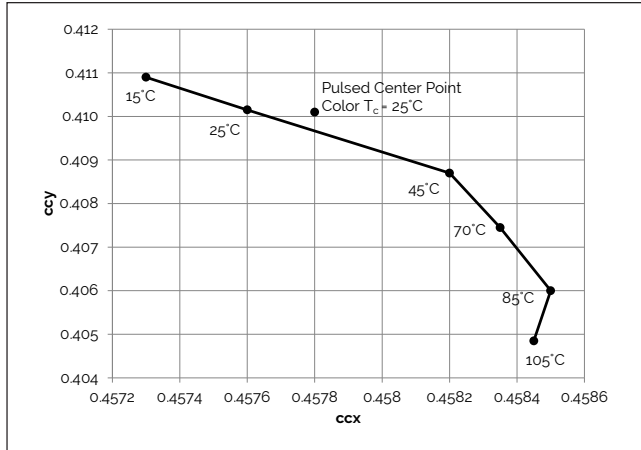

**Figure 12: 3000K, 97 CRI Color Shift vs. Case Temperature<sup>1</sup>**

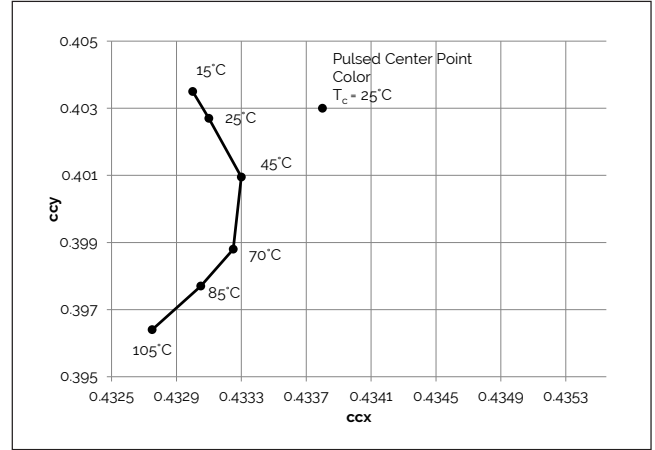

**Figure 13: 3000K Class A Color Shift vs. Case Temperature<sup>1</sup>**

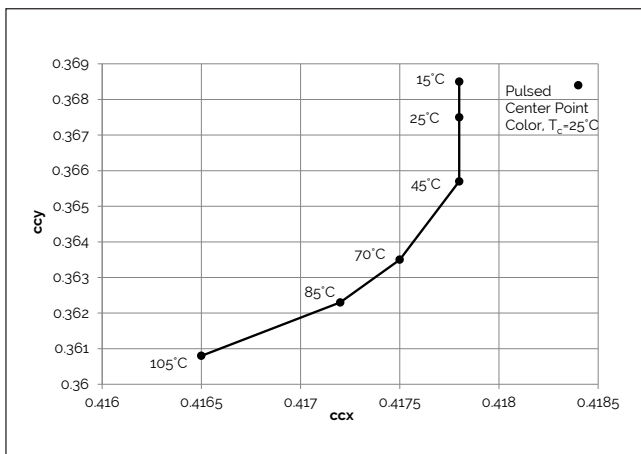

**Figure 14: 3500K Class A Color Shift vs. Case Temperature<sup>1</sup>**

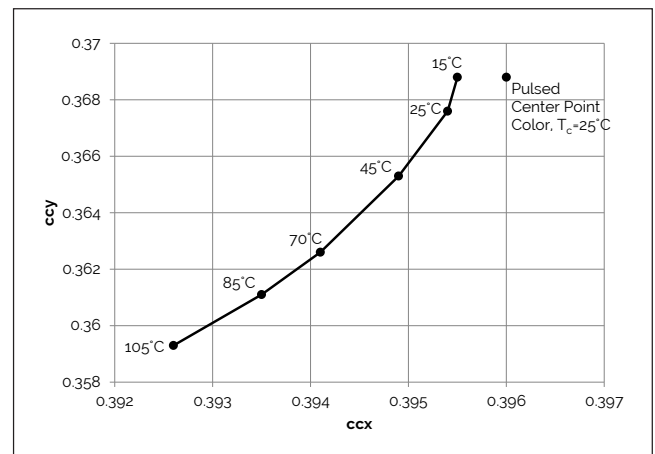

**Figure 15: 4000K Class A Color Shift vs. Case Temperature<sup>1</sup>**

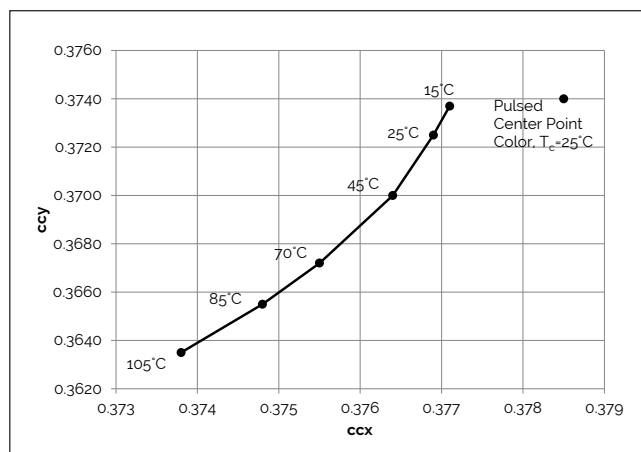

Notes for Figures 11-15:

1. Measurements made under DC test conditions at the nominal drive current.
2. Typical color shift is shown with a tolerance of  $\pm 0.002$ .

# Typical Radiation Pattern

Figure 16: Typical Spatial Radiation Pattern

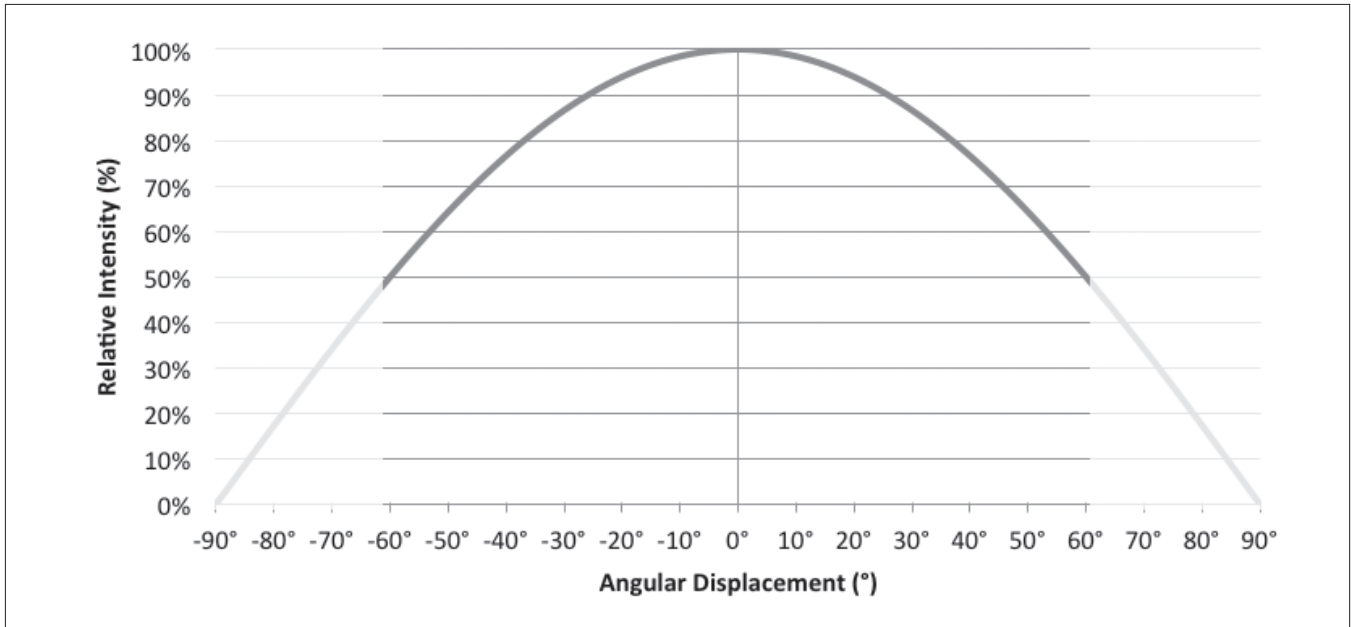

Note for Figure 16:

1. Typical viewing angle is 120°.
2. The viewing angle is defined as the off axis angle from the centerline where intensity is ½ of the peak value.

Figure 17: Typical Polar Radiation Pattern

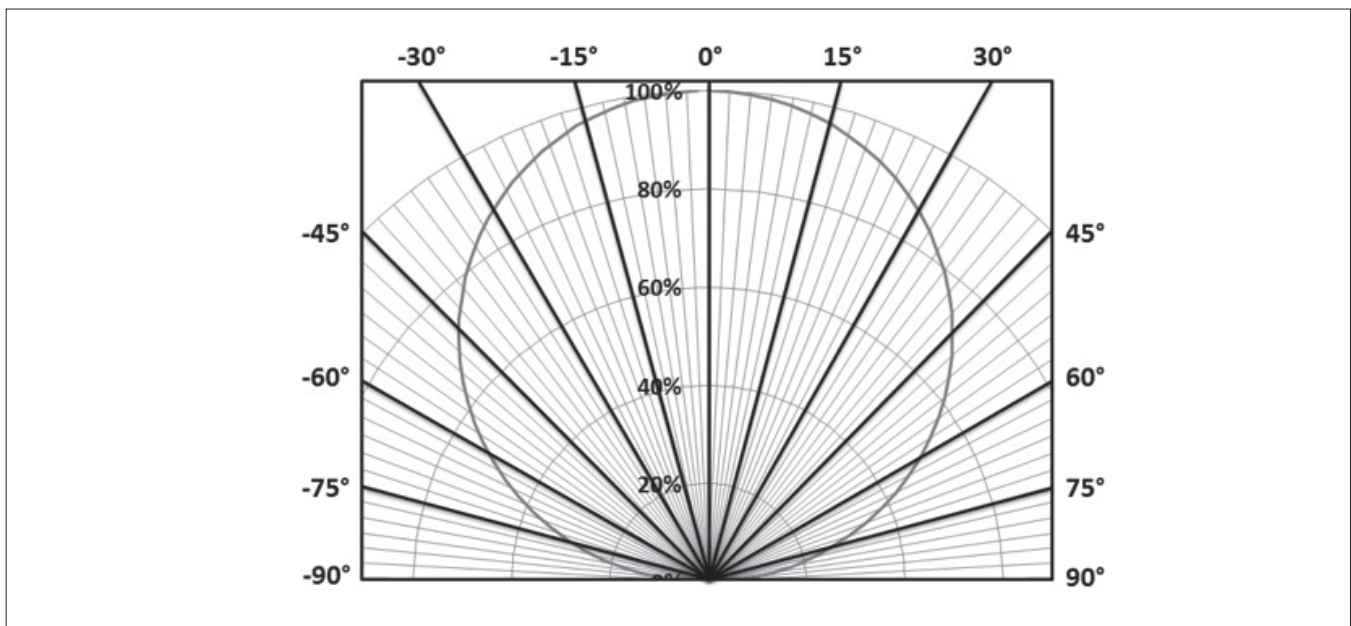

# Typical Color Spectrum

Figure 18: Typical Color Spectrum

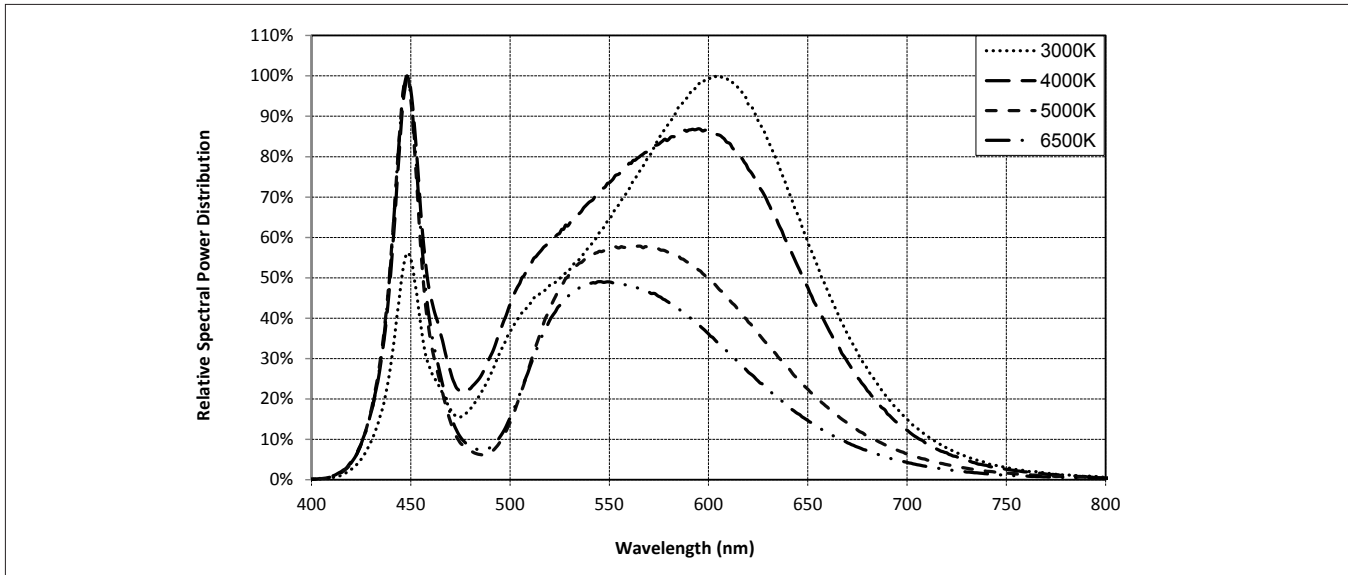

Note for Figure 18:

1. Color spectra measured at nominal current for  $T_j = T_c = 25^\circ\text{C}$ .
2. Color spectra shown is 3000K and 80 CRI.
3. Color spectra shown is 4000K and 80 CRI.
4. Color spectra shown is 5000K and 70 CRI.
4. Color spectra shown is 6500K and 70 CRI.

Figure 19: Typical Color Spectrum for Vero SE 13 with Décor Series

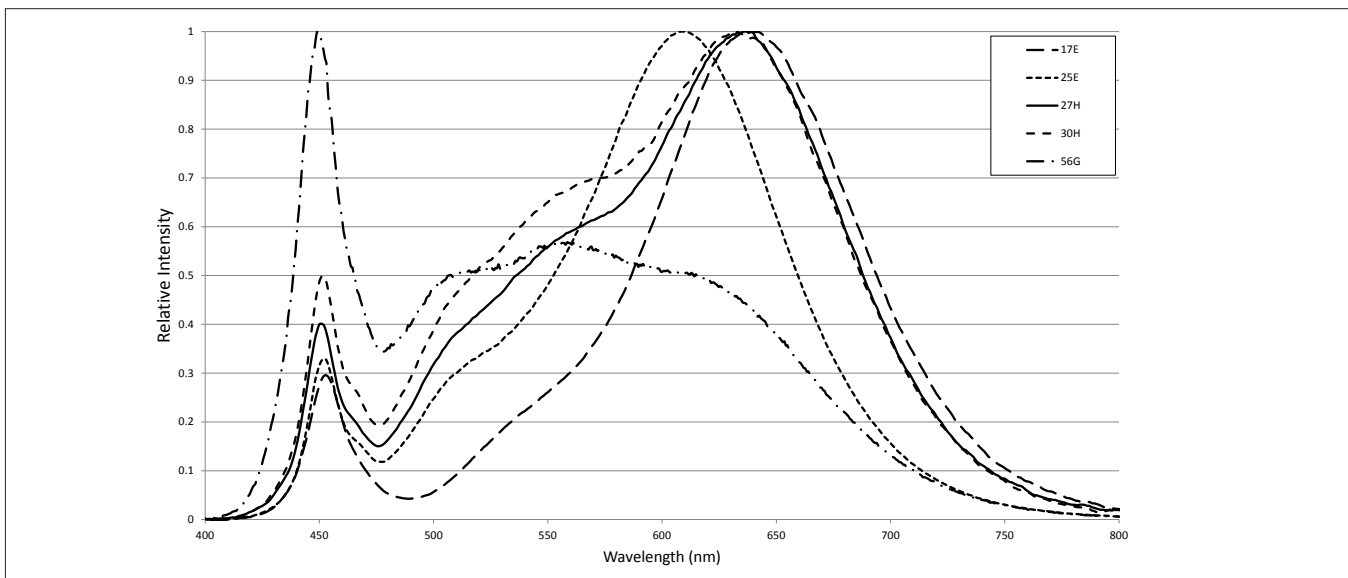

Note for Figure 19:

1. Color spectra measured at nominal current for  $T_j = T_c = 25^\circ\text{C}$ .



# Mechanical Dimensions

**Figure 20: Drawing for Vero SE 13 LED Array**

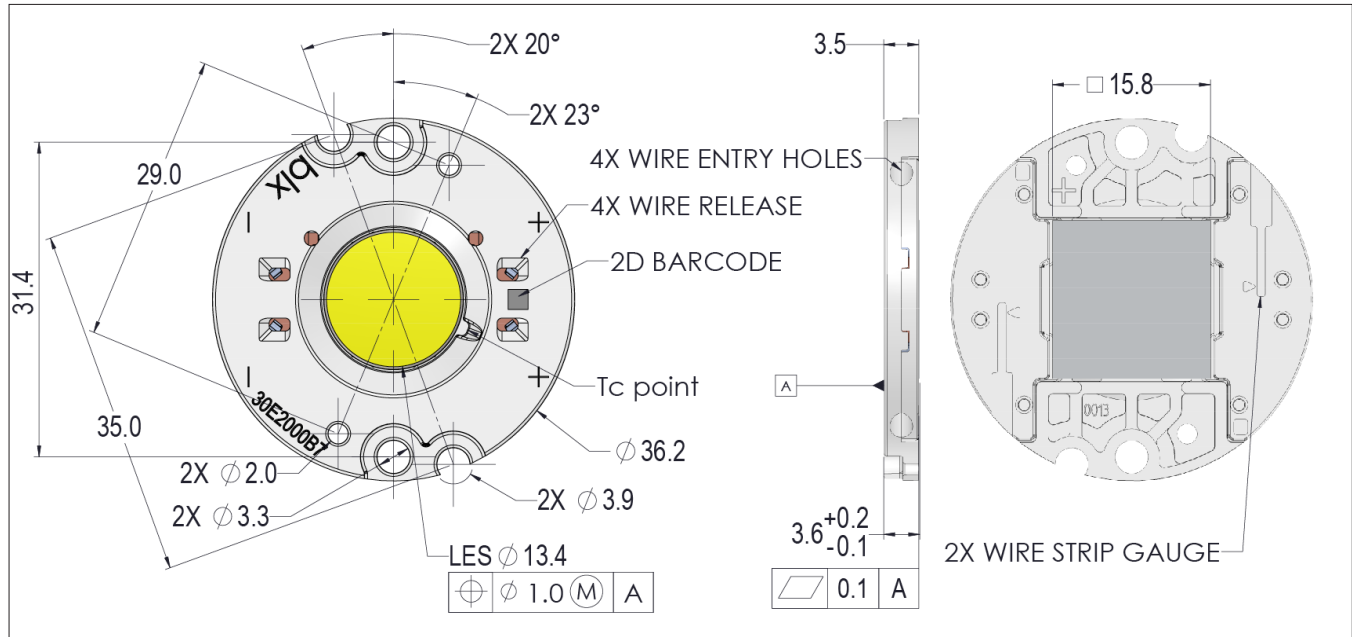

Notes for Figure 20:

1. Drawings are not to scale.
2. Drawing dimensions are in millimeters.
3. Unless otherwise specified, tolerances are  $\pm 0.1$ mm.
4. Mounting holes (2X) are for M3 screws.
5. Bridgelux recommends two tapped holes for mounting screws with  $31.4 \pm 0.10$ mm center-to-center spacing.
6. Screws with flat shoulders (pan, dome, button, round, truss, mushroom) provide optimal torque control. Do NOT use flat, countersink, or raised head screws.
7. The optical center of the LED Array is nominally defined by the mechanical center of the array to a tolerance of  $\pm 0.2$ mm.
8. Bridgelux maintains a flatness of 0.10mm across the mounting surface of the array.

# Color Binning Information

**Figure 21: Graph of Warm and Neutral White Test Bins in xy Color Space**

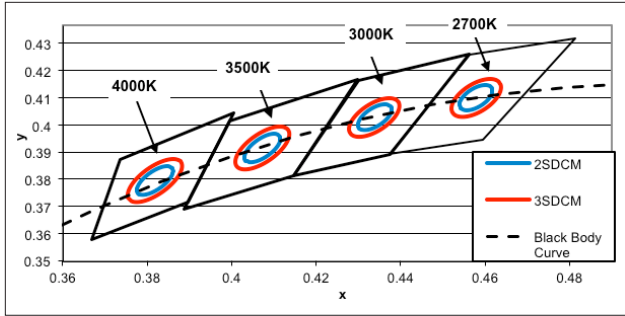

Note: Pulsed Test Conditions,  $T_c = 25^\circ\text{C}$

**Table 8: Warm and Neutral White xy Bin Coordinates and Associated Typical CCT**

Bin Code	2700K	3000K	3500K	4000K
ANSI Bin (for reference only)	(2580K - 2870K)	(2870K - 3220K)	(3220K - 3710K)	(3710K - 4260K)
73 (3 SDCM)	(2651K - 2794K)	(2968K - 3136K)	(3369K - 3586K)	(3851K - 4130K)
72 (2 SDCM)	(2674K - 2769K)	(2995K - 3107K)	(3404K - 3548K)	(3895K - 4081K)
Center Point (x,y)	(0.4578, 0.4101)	(0.4338, 0.403)	(0.4073, 0.3917)	(0.3818, 0.3797)

**Figure 22: Graph of Cool White Test Bins in xy Color Space**

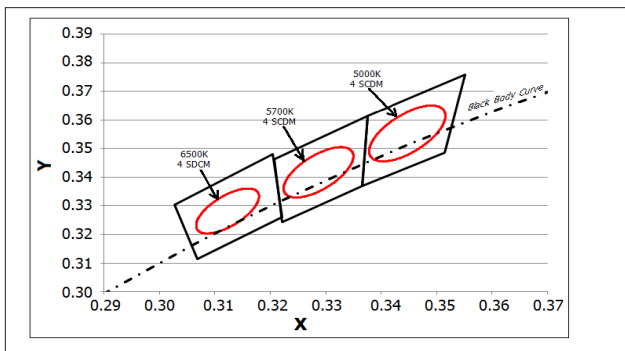

Note: Pulsed Test Conditions,  $T_c = 25^\circ\text{C}$

**Table 9: Cool White xy Bin Coordinates and Associated Typical CCT (product is hot targeted to  $T_c = 85^\circ\text{C}$ )**

Bin Code	5000K	5700K	6500K
ANSI Bin (for reference only)	(4745K - 5311K)	(5312K - 6022K)	(6022K - 7042K)
74 (4 SDCM)	(4801K - 5282K)	(5829K - 5481K)	(6270K - 6765K)
Center Point (x,y)	(0.3447, 0.3553)	(0.3287, 0.3417)	(0.3123, 0.3282)

# Packaging and Labeling

Figure 23: Drawing for Vero SE 13 Packaging Tray

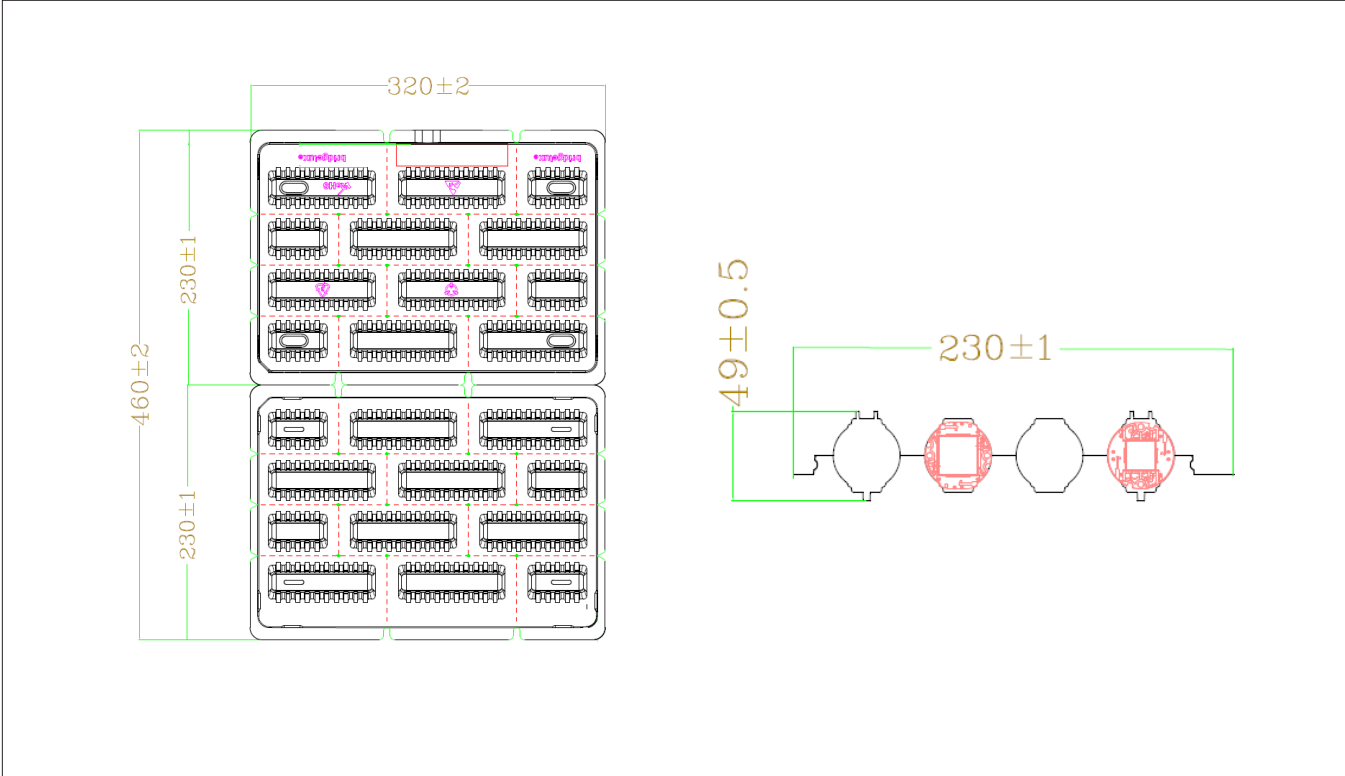

- Notes for Figure 23:
- 1. Dimensions are in millimeters.
  - 2. Drawings are not to scale.

# Packaging and Labeling

**Figure 24: Vero SE Series Packaging and Labeling**

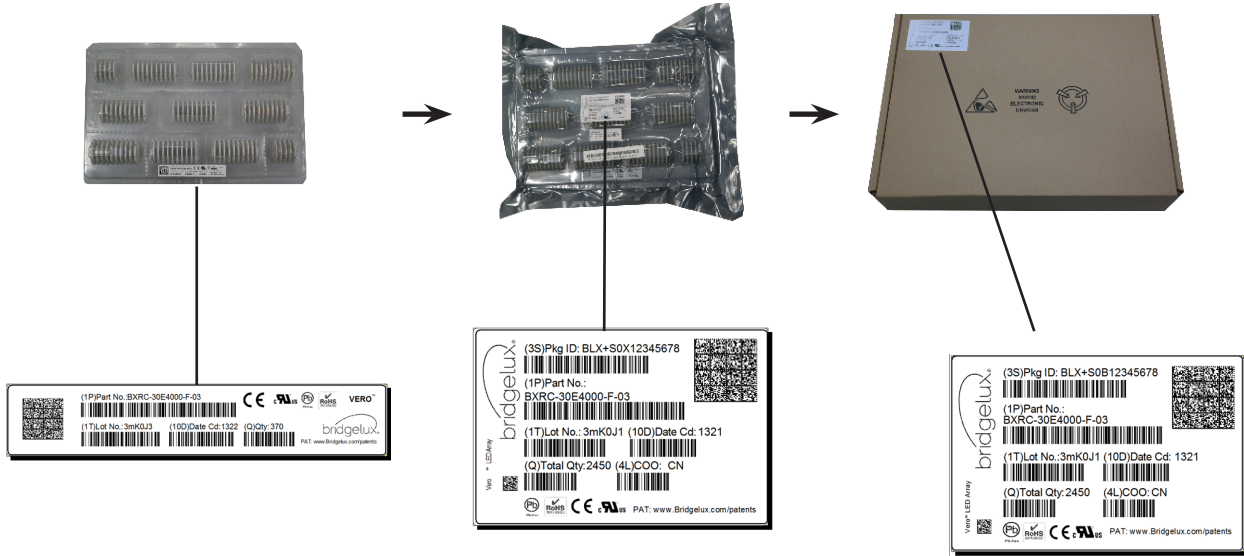

Notes for Figure 24:

1. Each tray holds 100 COBs.
2. Each tray is vacuum sealed in an anti-static bag and placed in its own box.
3. Each tray, bag and box is to be labeled as shown above.

**Figure 25: Vero SE Product Labeling**

Bridgelux COB arrays have laser markings on the back side of the substrate to help with product identification. In addition to the product identification markings, Bridgelux COB arrays also contain markings for internal Bridgelux manufacturing use only. The image below shows which markings are for customer use and which ones are for Bridgelux internal use only. The Bridgelux internal manufacturing markings are subject to change without notice, however these will not impact the form, function or performance of the COB array.



Customer Use- 2D Barcode  
Scannable barcode provides product part number and other Bridgelux internal production information.

Customer Use- Product part number

**30E2000C 73 2F**

Customer Use- V<sub>f</sub> Bin Code included to enable greater luminaire design flexibility. Refer to ANg2 for bin code definitions.

# Design Resources

## Application Notes

Bridgelux has developed a comprehensive set of application notes and design resources to assist customers in successfully designing with the Vero product family of LED array products. For all available application notes visit [www.bridgelux.com](http://www.bridgelux.com).

## Optical Source Models

Optical source models and ray set files are available for all Bridgelux products. For a list of available formats, visit [www.bridgelux.com](http://www.bridgelux.com).

## 3D CAD Models

Three dimensional CAD models depicting the product outline of all Bridgelux Vero LED arrays are available in both IGS and STEP formats. Please contact your Bridgelux sales representative for assistance.

## LM80

LM80 testing has been completed and the LM80 report is now available. Please contact your Bridgelux sales representative for LM-80 report.

# Precautions

## CAUTION: CHEMICAL EXPOSURE HAZARD

Exposure to some chemicals commonly used in luminaire manufacturing and assembly can cause damage to the LED array. Please consult Bridgelux Application Note AN31 for additional information.

## CAUTION: RISK OF BURN

Do not touch the Vero LED array during operation. Allow the array to cool for a sufficient period of time before handling. The Vero LED array may reach elevated temperatures such that could burn skin when touched.

## CAUTION

### CONTACT WITH LIGHT EMITTING SURFACE (LES)

Avoid any contact with the LES. Do not touch the LES of the LED array or apply stress to the LES (yellow phosphor resin area). Contact may cause damage to the LED array.

Optics and reflectors must not be mounted in contact with the LES (yellow phosphor resin area). Optical devices may be mounted on the top surface of the plastic housing of the Vero LED array. Use the mechanical features of the LED array housing, edges and/or mounting holes to locate and secure optical devices as needed.

# Disclaimers

## MINOR PRODUCT CHANGE POLICY

The rigorous qualification testing on products offered by Bridgelux provides performance assurance. Slight cosmetic changes that do not affect form, fit, or function may occur as Bridgelux continues product optimization.

## STANDARD TEST CONDITIONS

Unless otherwise stated, array testing is performed at the nominal drive current.

# About Bridgelux: We Build Light That Transforms

At Bridgelux, we help companies, industries and people experience the power and possibility of light. Since 2002, we've designed LED solutions that are high performing, energy efficient, cost effective and easy to integrate. Our focus is on light's impact on human behavior, delivering products that create better environments, experiences and returns—both experiential and financial. And our patented technology drives new platforms for commercial and industrial luminaires.

**For more information about the company, please visit**  
**bridgelux.com**  
**twitter.com/Bridgelux**  
**facebook.com/Bridgelux**  
**[https://www.linkedin.com/company/bridgelux-inc-\\_2](https://www.linkedin.com/company/bridgelux-inc-_2)**  
**WeChat ID: BridgeluxInChina**



101 Portola Avenue  
Livermore, CA 94551  
Tel (925) 583-8400  
**[www.bridgelux.com](http://www.bridgelux.com)**

© 2016-2017 Bridgelux, Inc. All rights reserved 2016. Product specifications are subject to change without notice. Bridgelux, the Bridgelux stylized logo design and Vero are registered trademarks, and Decor Series is a trademark of Bridgelux, Inc. All other trademarks are the property of their respective owners.

**Bridgelux Vero SE 13 Array Series Product Data Sheet DS121 Rev. C (1/2017)**